

# KOBELCO

Performance  Design

## SK130<sub>LC</sub>

- Bucket capacity:  
0.24 – 0.70 m<sup>3</sup>
- Engine power:  
78.5 kW / 2,000 min<sup>-1</sup>
- Operating weight:  
14,200 – 17,100 kg



Complies with the EU Stage V  
exhaust emission regulation

**We Save You Fuel**  
Achieving a Low-Carbon Society



# Performance Design

SK130LC of KOBELCO has realised a completely new value by harmonising PERFORMANCE – greater efficiency and productivity with an increased power and speed and DESIGN – operator-based operability and comfort, refusing to accept any compromises.

In pursuit of unique and matchless machines which are unforgettable once you use them, KOBELCO will continue to rise to meet every challenge.



# THE ULTIMATE IN SIMPLE AND ELEGANT DESIGN

Our pursuit of functional beauty and aesthetic sense produced a new interior design.

## Jog dial

This jog dial integrates multiple functions to realise simple operations. Even with gloved hands, the operator can set various machine conditions without stress.

## LED backlights

The switches and dials have LED backlights – they provide a bright, clear view in the dark and set a luxurious mood.







# UNFORGETTABLE COMFORT

## ① Air suspension seat

A GRAMMER seat is installed as standard equipment, which achieves excellent shock absorption and superior ride comfort.

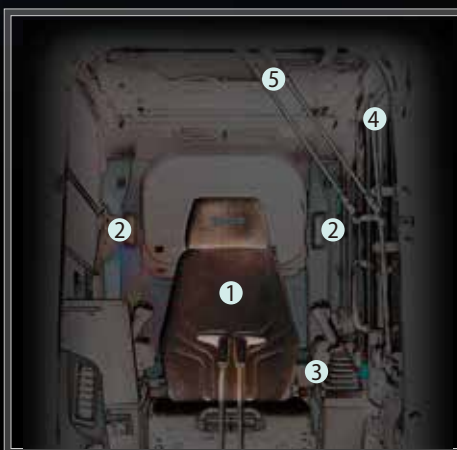

## ② Air conditioner blowing from the rear

Air is blown against the operator's waist and the back of their head, offering more comfortable operation.

## ③ Lever angles allow for comfortable operations

The operator can move the levers horizontally without twisting their wrist, which reduces the fatigue caused by the operations.



## New Hydraulic Control

Our newly upgraded hydraulic control system responds to shorter lever strokes than current models, delivering swifter, more precise movement and improved lever operability.

## ④ LED door light

The LED interior light automatically turns on when the door is opened or when the ignition is set to OFF.

This ensures easy entry and exit at nighttime.

## ⑤ Parallel wipers secure a wide field of view



# KOBELCO

ECO

04:33



SETTING MENU



PICTURE OF CAMERA



CLOCK SETTING



SCREEN BRIGHTNESS



MAINTENANCE



CONSUMPTION



LANGUAGE SELECTION



FLOW RATE 260 l/min



# A WIDER VIEW BRINGS A WIDER RANGE OF USE

## 10-inch colour monitor (the largest in the industry)

The easy-to-operate menu screen facilitates reading of important information. Images from the built-in cameras can be checked on the large screen, which helps secure safety. In addition, each icon has become easy to recognise. A password is required when starting the engine for greater security.



The right camera and rear camera (right side view mode)

The right camera and rear camera (straight view mode)

The right camera and rear camera (right side view mode)

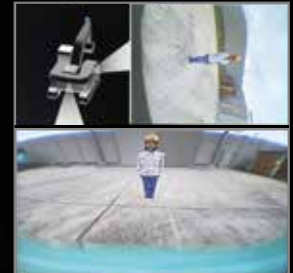

The right camera and rear camera (straight view mode)



The bird's-eye view



The eagle eye view

## Right and rear cameras

Images from the right camera and rear camera are displayed together on the large colour monitor. The right camera view can be selected between the straight view mode and right side view mode.

In addition, the bird's-eye view mode can also be selected. As an optional setting, the eagle eye view mode can also be selected.

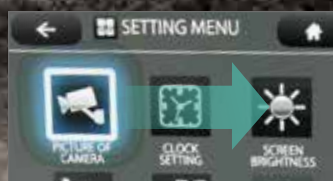

## Screen display linked with the jog dial operation

The jog dial can be operated as desired without causing stress. Turn the jog dial to the right or left to select an item and press the dial to confirm the selection.





## EXPERIENCING A COMPETENT PERFORMANCE

### Excellent machine stability, plus a STAGE V compliant engine

Equipped with the new STAGE V engine, the SK130LC features outstanding stability thanks to an innovative new shape for conventional excavator, as well as a larger counterweight.



Model: ISUZU 4JJ1XDDV A01

Engine output

**78.5 kW / 2,000 min<sup>-1</sup>**



»» Bucket digging force

Increased by **105.4** kN

Lifting capacity

**3,890** kg

(Reach 6.0 m, ground level over front 2.84 m arm with additional 600 kg weight)



# GREATER MULTI-FUNCTION CAPABILITIES

## Attachment mode

The flow-rate modes of the bucket, breaker, nibbler, and rotating grapple are set before delivery, which allows you to start operating immediately. Mode settings for other attachments, such as the tilt rotator, can easily be added or changed.



## Adjustment for hydraulic flow

Divide ratio of hydraulic flow can be adjusted by service factory for custom usage.



# EASY MAINTENANCE



**Standard FOPS overhead cab guard**

The standard FOPS guard can be tilted open for easy window cleaning. Meets standard FOPS, Top Guard Level II requirements. (ISO10262)



**Engine maintenance**



**Two-stage air filter**



**Urea tank**

Urea filter cap is placed on the step for easy access.



**Left side (radiator and cooling system elements)**

Laid out for easy access to radiator and cooling system.



**Right side**



**Fuel filter**



**Pre-filter with integrated water separator**



**Engine oil filter**





# KOMEXS KOBELCO MONITORING EXCAVATOR SYSTEM



## Remote Monitoring for Peace of Mind

KOMEXS (Kobelco Monitoring Excavator System) uses satellite communication and internet to relay data, and therefore can be deployed in areas where other forms of communication are difficult. When a hydraulic excavator is fitted with this system, data on the machine's operation, such as operating hours, location, fuel consumption, and maintenance status can be obtained remotely.

## Direct Access to Operational Status

### Location Data

Accurate location data can be obtained even from sites where communications are difficult.

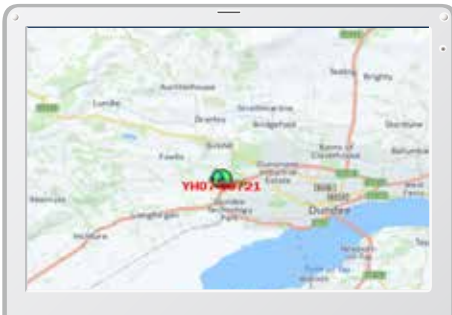

Latest location

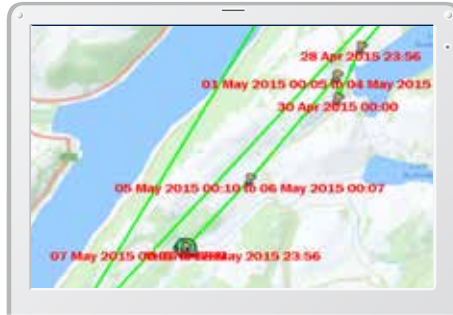

Location records

Type of Operation	Working Hrs	Ratio
Total Working Hrs	159 Hrs	100 %
Digging Hrs	72.2 Hrs	43 %
Traveling Hrs	18.3 Hrs	11 %
Idle Hrs	15.9 Hrs	9 %
Opt Alt Hrs	52.5 Hrs	37 %
Crane Mode Hrs	0 Hrs	0 %

Work data

## Operating Hours

- A comparison of operating times of machines at multiple locations shows which locations are busier and more profitable.
- Operating hours on site can be accurately recorded, for running time calculations needed for rental machines, etc.

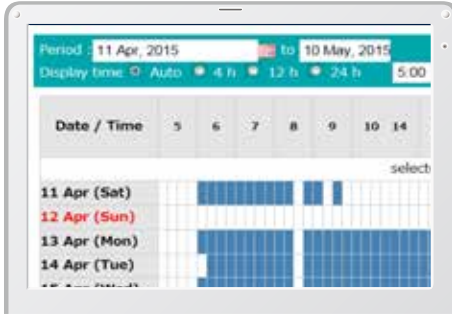

Daily report

## Fuel Consumption Data

Data on fuel consumption and idling times can be used to indicate improvements in fuel consumption.

Work mode	Working Hrs	Total Fuel Consumption
H mode	2:06	24.5 L
S mode	0:00	0.0 L
E mode	169:19	1489.7 L
<b>TOTAL</b>	<b>171:25</b>	<b>1514.2 L</b>

Fuel consumption

## Graph of Work Content

The graph shows how working hours are divided among different operating categories, including digging, idling, travelling and optional operations.



Work status

## Maintenance Data and Warning Alerts

### Machine Maintenance Data

- Provides maintenance status of separate machines operating at multiple sites.
- Maintenance data is also relayed to KOBELCO service personnel, for more efficient planning of periodic servicing.

Model	Serial No.	Hour Meter	Engine Oil
SK135SRLC-3/SK140SRL	YH07-09721	734 Hr	434
SK135SRLC-3/SK140SRL	YH07-09789	73 Hr	429
SK210LC-9	YQ13-10454	960 Hr	58
SK210LC-9	YQ13-10481	549 Hr	498
SK75SR-	YT08-20374		

Maintenance

### Warning Alerts

This system warns an alert if an anomaly is sensed, preventing damage that could result in machine downtime.

## Alarm Information Can Be Received through E-mail

Alarm information or maintenance notice can be received through E-mail, using a computer or cell phone.



Alarm messages can be received on mobile device.

## Daily/Monthly Reports

Operational data downloaded onto a computer helps in formulating daily and monthly reports.

## Security System

### Engine Start Alarm

The system can be set an alarm if the machine is operated outside designated time.

Engine start alarm outside prescribed work time

### Area Alarm

It can be set an alarm if the machine is moved out of its designated area to another location.

Alarm for outside of reset area

# Specifications



## Engine

Model	ISUZU MOTORS LIMITED 4JJ1XDDV A01
Type	Four-stroke, liquid-cooled, direct injection diesel, turbo charged complies with EU Stage V exhaust emission regulation
No. of cylinders	4
Bore and stroke	95.4 mm x 104.9 mm
Displacement	2.999 L
Rated power output	71.3 kW/2,000 min <sup>-1</sup> (ISO 9249: with fan)
	78.5 kW/2,000 min <sup>-1</sup> (ISO 14396: without fan)
Max. torque	354 N·m/1,800 min <sup>-1</sup> (ISO 9249: with fan)
	375 N·m/1,800 min <sup>-1</sup> (ISO 14396: without fan)



## Hydraulic system

Pump	
Type	Two variable displacement piston pumps + one gear pump
Max. discharge flow	2 x 130 L/min
	1 x 50 L/min
Relief valve setting	
Boom, arm and bucket	34.3 MPa
Travel circuit	34.3 MPa
Swing circuit	28.0 MPa
Control circuit	5.0 MPa
Pilot control pump	Gear type
Main control valves	12-spool
Oil cooler	Air cooled type



## Swing system

Swing motor	One fixed displacement piston motor
Brake	Hydraulic; locking automatically when the swing control lever is in the neutral position
Parking brake	Wet multiple plate
Swing speed	11.0 min <sup>-1</sup>
Tail swing radius	2,190 mm
Swing torque	40.4 kN·m



## Attachments

Backhoe bucket and combination

Use		Backhoe bucket							
		Normal digging							
Bucket capacity	ISO heaped	m <sup>3</sup>	0.24	0.31	0.38	0.45	0.50	0.57	0.70
	Struck	m <sup>3</sup>	0.20	0.23	0.28	0.35	0.38	0.43	0.50
Opening width	With side cutter	mm	590	700	800	915	1,000	1,100	—
	Without side cutter	mm	500	600	700	815	900	1,000	1,150
No. of teeth			3	3	4	4	5	5	5
Bucket weight		kg	280	300	340	360	380	400	410
Combination	2.38 m arm		○	○	○	○	⊙	△	△
	2.84 m arm		○	○	⊙	△	×	×	×

⊙ Standard ○ Recommended △ Loading only × Not recommended



## Travel system

Travel motors	Variable displacement piston, two-speed motors
Travel brakes	Hydraulic brake
Parking brakes	Wet multiple plate
Travel shoes	46 each side
Travel speed	3.4/5.6 km/h
Drawbar pulling force	141 kN (SAE)
Gradeability	70% {35°}



## Cab & control

Cab	
All-weather, sound-suppressed steel cab mounted on the silicon-sealed viscous mounts and equipped with a heavy, insulated floor mat	
Control	
Two hand levers and two foot pedals for travel	
Two hand levers for excavating and swing	
Electric rotary-type engine throttle	
Noise levels	
External	101 dB(A)
Operator	70 dB(A)



## Boom, arm & bucket

Boom cylinders	100 mm x 1,092 mm
Arm cylinder	115 mm x 1,116 mm
Bucket cylinder	100 mm x 903 mm



## Refilling capacities & lubrications

Fuel tank	280 L
Cooling system	16 L
Engine oil	17 L
Travel reduction gear	2 x 2.1 L
Swing reduction gear	1.65 L
Hydraulic oil tank	96.7 L tank oil level
	180 L hydraulic system
DEF/Urea tank	33.9 L





## Working ranges

Unit: m

Boom	4.68 m	
Range	Arm	
	2.38 m	2.84 m
a- Max. digging reach	8.34	8.78
b- Max. digging reach at ground level	8.17	8.62
c- Max. digging depth	5.52	5.98
d- Max. digging height	8.45	8.75
e- Max. dumping clearance	6.08	6.38
f- Min. dumping clearance	2.28	1.84
g- Max. vertical wall digging depth	4.45	4.91
h- Min. swing radius	2.75	2.84
i- Horizontal digging stroke at ground level	4.20	4.68
j- Digging depth for 2.4 m (8') flat bottom	5.28	5.77
Bucket capacity ISO heaped m <sup>3</sup>	0.50	0.38

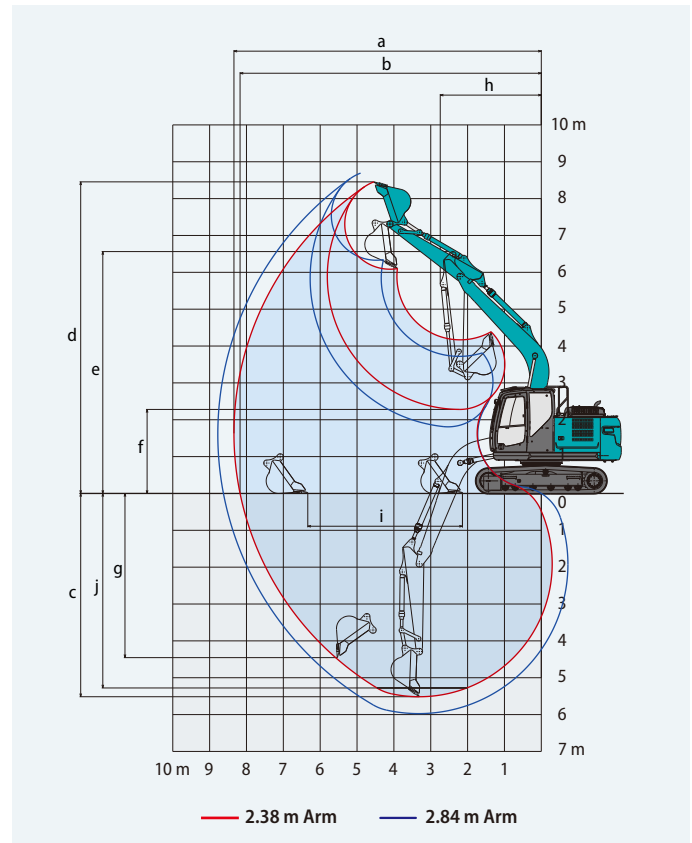

## Digging force (ISO 6015)

Unit: kN

Arm length	2.38 m	2.84 m
Bucket digging force	105.4	
Arm crowding force	64.0	58.0



## Dimensions

Unit: mm

Arm length	2.38 m	2.84 m
A Overall length	7,770	7,810
B Overall height (to top of boom)	2,770	3,150
C Overall width	2,590**	
D Overall height (to top of cab)	2,920	
E Ground clearance of rear end*	915	
F Ground clearance*	445	

G Tail swing radius	2,190
G' Distance from centre of swing to rear end	2,170
H Tumbler distance	3,040
I Overall length of crawler	3,780
J Track gauge	1,990
K Shoe width	600
L Overall width of upperstructure	2,490

\*Without including height of shoe lug \*\*600 mm shoe

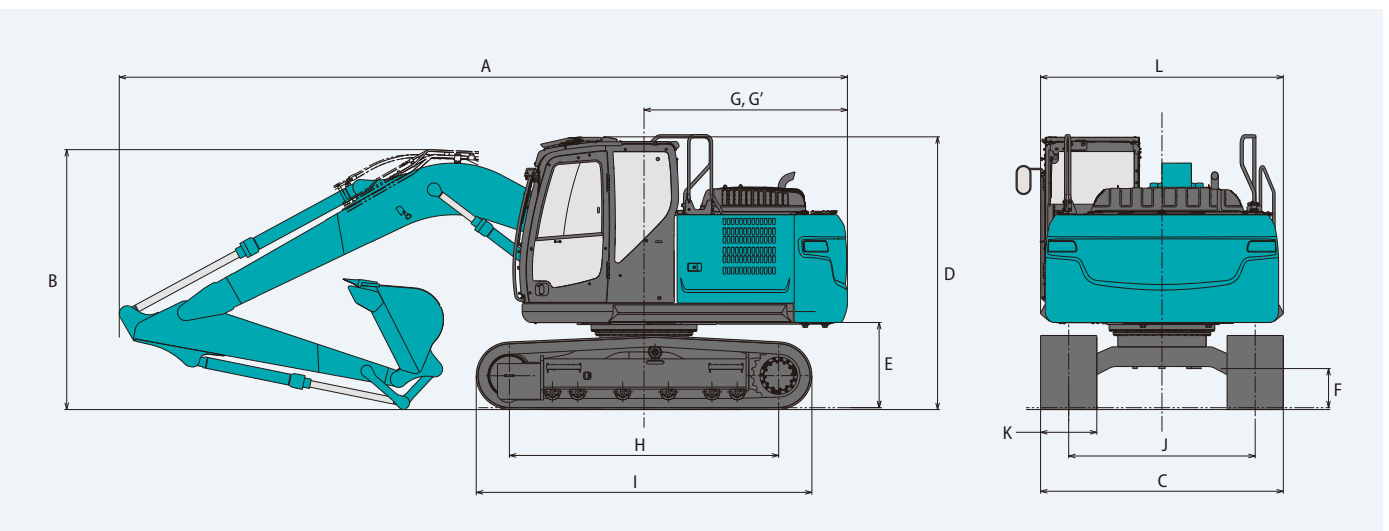

# Two-piece boom specifications



## Working ranges

Unit: m

Range	Arm	Two-piece boom	
		2.38 m	2.84 m
a- Max. digging reach		8.80	9.24
b- Max. digging reach at ground level		8.64	9.09
c- Max. digging depth		5.70	6.16
d- Max. digging height		8.83	9.11
e- Max. dumping clearance		6.48	6.76
f- Min. dumping clearance		0.44	0.03
g- Max. vertical wall digging depth		4.59	5.06
h- Min. swing radius		2.94	2.99
i- Horizontal digging stroke at ground level		5.70	6.58
j- Digging depth for 2.4 m (8') flat bottom		5.58	6.04
Bucket capacity ISO heaped m <sup>3</sup>		0.50	0.38

## Digging force (ISO 6015)

Unit: kN

Arm length	2.38 m	2.84 m
Bucket digging force	105.4	
Arm crowding force	64.0	58.0

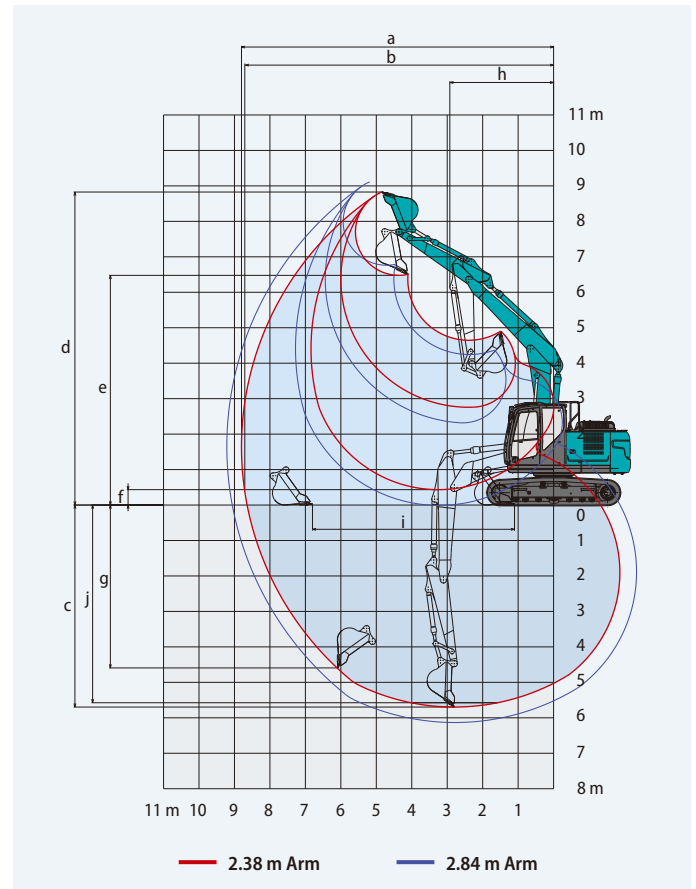

## Dimensions

Unit: mm

Arm length	2.38 m	2.84 m
A Overall length	8,260	8,330
B Overall height (to top of boom)	2,780	3,100
C Overall width	2,590	
D Overall height (to top of cab)	2,920	
E Ground clearance of rear end*	915	
F Ground clearance*	410	
G Tail swing radius	2,190	
G' Distance from centre of swing to rear end	2,170	

H Tumbler distance	3,040
I Overall length of crawler	3,780
J Track gauge	1,990
K Shoe width	600
L Overall width of upperstructure	2,490
M Dozer blade (up/down)	515/575

\*Without including height of shoe lug \*\*600 mm shoe

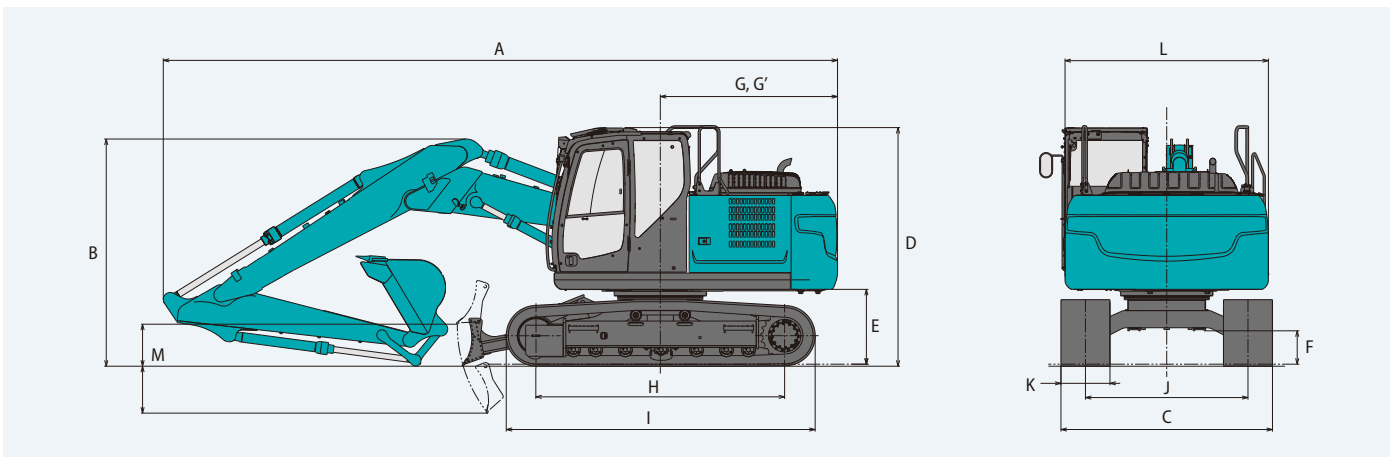

# Operating weight & ground pressure

# SK130LC

SK130LC-11

## Standard boom

Boom: 4.68 m Arm: 2.38 m Bucket: 0.5 m<sup>3</sup> ISO heaped bucket Dozer: without

	HD shoes				Triple grouser shoes (even height)	BS Geogrip shoes	Rubber pad shoes
Shoes (mm)	500	600	700	800	700	500	500
Counterweight	standard						
Ground pressure (kPa)	43.0	36.4	31.7	28.2	31.0	42.3	43.1
Operating weight (kg)	14,400	14,700	14,900	15,100	14,600	14,300	14,600

	HD shoes				Triple grouser shoes (even height)	BS Geogrip shoes	Rubber pad shoes
Shoes (mm)	500	600	700	800	700	500	500
Counterweight	+ 600 kg						
Ground pressure (kPa)	44.7	37.9	33.0	29.3	32.2	44.1	44.8
Operating weight (kg)	15,000	15,300	15,500	15,700	15,200	14,900	15,200

Boom: 4.68 m Arm: 2.38 m Bucket: 0.5 m<sup>3</sup> ISO heaped bucket Dozer: with

	HD shoes			Triple grouser shoes (even height)	BS Geogrip shoes	Rubber pad shoes
Shoes (mm)	500	600	700	700	500	500
Dozer (mm)	2,490	2,590	2,690	2,690	2,490	2,490
Counterweight	standard					
Ground pressure (kPa)	45.3	38.4	33.5	32.7	44.7	45.4
Operating weight (kg)	15,200	15,500	15,750	15,400	15,100	15,400

	HD shoes			Triple grouser shoes (even height)	BS Geogrip shoes	Rubber pad shoes
Shoes (mm)	500	600	700	700	500	500
Dozer (mm)	2,490	2,590	2,690	2,690	2,490	2,490
Counterweight	+ 600 kg					
Ground pressure (kPa)	47.1	39.9	34.7	33.9	46.4	47.2
Operating weight (kg)	15,800	16,100	16,350	16,000	15,700	16,000

Boom: 4.68 m Arm: 2.84 m Bucket: 0.38 m<sup>3</sup> ISO heaped bucket Dozer: without

	HD shoes				Triple grouser shoes (even height)	BS Geogrip shoes	Rubber pad shoes
Shoes (mm)	500	600	700	800	700	500	500
Counterweight	standard						
Ground pressure (kPa)	43.0	36.4	31.7	28.2	31.0	42.3	43.1
Operating weight (kg)	14,500	14,700	14,900	15,200	14,600	14,300	14,600

	HD shoes				Triple grouser shoes (even height)	BS Geogrip shoes	Rubber pad shoes
Shoes (mm)	500	600	700	800	700	500	500
Counterweight	+ 600 kg						
Ground pressure (kPa)	44.8	37.9	33.0	29.3	32.2	44.1	44.9
Operating weight (kg)	15,100	15,300	15,500	15,800	15,200	14,900	15,200

Boom: 4.68 m Arm: 2.84 m Bucket: 0.38 m<sup>3</sup> ISO heaped bucket Dozer: with

	HD shoes			Triple grouser shoes (even height)	BS Geogrip shoes	Rubber pad shoes
Shoes (mm)	500	600	700	700	500	500
Dozer (mm)	2,490	2,590	2,690	2,690	2,490	2,490
Counterweight	standard					
Ground pressure (kPa)	45.4	38.5	33.5	32.7	44.7	45.5
Operating weight (kg)	15,300	15,500	15,800	15,400	15,100	15,400

	HD shoes			Triple grouser shoes (even height)	BS Geogrip shoes	Rubber pad shoes
Shoes (mm)	500	600	700	700	500	500
Dozer (mm)	2,490	2,590	2,690	2,690	2,490	2,490
Counterweight	+ 600 kg					
Ground pressure (kPa)	47.2	39.9	34.8	34.0	46.5	47.2
Operating weight (kg)	15,900	16,100	16,400	16,000	15,700	16,000

# Operating weight & ground pressure

## Two-piece boom

Boom: Two-piece Arm: 2.38 m Bucket: 0.5 m<sup>3</sup> ISO heaped bucket Dozer: without

Shoes (mm)	HD shoes				Triple grouser shoes (even height)	BS Geogrip shoes	Rubber pad shoes
	500	600	700	800			
Counterweight	standard						
Ground pressure (kPa)	45.0	38.2	33.2	29.5	32.5	44.4	45.1
Operating weight (kg)	15,100	15,400	15,600	15,900	15,300	15,000	15,300

Shoes (mm)	HD shoes				Triple grouser shoes (even height)	BS Geogrip shoes	Rubber pad shoes
	500	600	700	800			
Counterweight	+ 600 kg						
Ground pressure (kPa)	46.8	39.6	34.5	30.6	33.7	46.1	46.9
Operating weight (kg)	15,700	16,000	16,200	16,500	15,900	15,600	15,900

Boom: Two-piece Arm: 2.38 m Bucket: 0.5 m<sup>3</sup> ISO heaped bucket Dozer: with

Shoes (mm)	HD shoes				Triple grouser shoes (even height)	BS Geogrip shoes	Rubber pad shoes
	500	600	700	700			
Dozer (mm)	2,490	2,590	2,690	2,690	2,490	2,490	2,490
Counterweight	standard						
Ground pressure (kPa)	47.4	40.2	35.0	34.2	46.7	47.5	47.5
Operating weight (kg)	15,900	16,200	16,500	16,100	15,800	16,100	16,100

Shoes (mm)	HD shoes				Triple grouser shoes (even height)	BS Geogrip shoes	Rubber pad shoes
	500	600	700	700			
Dozer (mm)	2,490	2,590	2,690	2,690	2,490	2,490	2,490
Counterweight	+ 600 kg						
Ground pressure (kPa)	49.2	41.7	36.2	35.5	48.5	49.3	49.3
Operating weight (kg)	16,500	16,800	17,100	16,700	16,400	16,700	16,700

Boom: Two-piece Arm: 2.84 m Bucket: 0.38 m<sup>3</sup> ISO heaped bucket Dozer: without

Shoes (mm)	HD shoes				Triple grouser shoes (even height)	BS Geogrip shoes	Rubber pad shoes
	500	600	700	800			
Counterweight	standard						
Ground pressure (kPa)	45.0	38.1	33.2	29.5	32.5	44.4	45.1
Operating weight (kg)	15,100	15,400	15,600	15,900	15,300	15,000	15,300

Shoes (mm)	HD shoes				Triple grouser shoes (even height)	BS Geogrip shoes	Rubber pad shoes
	500	600	700	800			
Counterweight	+ 600 kg						
Ground pressure (kPa)	46.8	39.6	34.5	30.6	33.7	46.1	46.9
Operating weight (kg)	15,700	16,000	16,200	16,500	15,800	15,600	15,900

Boom: Two-piece Arm: 2.84 m Bucket: 0.38 m<sup>3</sup> ISO heaped bucket Dozer: with

Shoes (mm)	HD shoes				Triple grouser shoes (even height)	BS Geogrip shoes	Rubber pad shoes
	500	600	700	700			
Dozer (mm)	2,490	2,590	2,690	2,690	2,490	2,490	2,490
Counterweight	standard						
Ground pressure (kPa)	47.4	40.2	34.9	34.2	46.7	47.5	47.5
Operating weight (kg)	15,900	16,200	16,400	16,100	15,800	16,100	16,100

Shoes (mm)	HD shoes				Triple grouser shoes (even height)	BS Geogrip shoes	Rubber pad shoes
	500	600	700	700			
Dozer (mm)	2,490	2,590	2,690	2,690	2,490	2,490	2,490
Counterweight	+ 600 kg						
Ground pressure (kPa)	49.2	41.6	36.2	35.5	48.5	49.3	49.3
Operating weight (kg)	16,500	16,800	17,000	16,700	16,400	16,700	16,700

# Lift capacities

# SK130LC

SK130LC-11

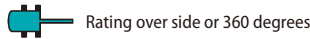
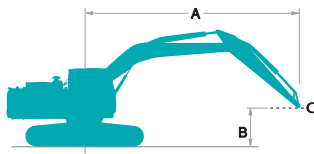

A - Reach from swing centerline to arm top

B - Arm top height above/below ground

C - Lift point

Relief valve setting: 34.3 MPa

SK130LC		Arm: 2.84 m		Bucket: without		Counterweight: 2,400 kg		Shoe: 600 mm		Dozer: without						
B	A	1.5 m		3.0 m		4.5 m		6.0 m		7.5 m		At max. reach		Radius		
7.5 m	kg													*2,030	*2,030	4.64 m
6.0 m	kg								*2,110	*2,110				*1,700	*1,700	6.13 m
4.5 m	kg								*2,970	2,500				*1,590	*1,590	6.98 m
3.0 m	kg				*5,270	*5,270	*3,860	3,730	*3,330	2,400				*1,580	*1,580	7.43 m
1.5 m	kg				*7,870	6,190	*4,940	3,440	*3,670	2,270	*1,960	1,610		*1,670	1,590	7.55 m
G.L.	kg				*6,410	5,820	5,480	3,230	3,550	2,160				*1,850	1,620	7.36 m
-1.5 m	kg	*4,660	*4,660	*8,910	5,770	5,380	3,140	3,500	2,120					*2,220	1,790	6.83 m
-3.0 m	kg	*7,800	*7,800	*8,350	5,870	5,420	3,180							*3,070	2,230	5.87 m
-4.5 m	kg			*5,920	*5,920									*3,960	3,760	4.17 m

SK130LC		Arm: 2.84 m		Bucket: without		Counterweight: 2,400 kg + 600 kg		Shoe: 600 mm		Dozer: without						
B	A	1.5 m		3.0 m		4.5 m		6.0 m		7.5 m		At max. reach		Radius		
7.5 m	kg													*2,030	*2,030	4.64 m
6.0 m	kg								*2,110	*2,110				*1,700	*1,700	6.13 m
4.5 m	kg								*2,970	2,770				*1,590	*1,590	6.98 m
3.0 m	kg				*5,270	*5,270	*3,860	*3,860	*3,330	2,660				*1,580	*1,580	7.43 m
1.5 m	kg				*7,870	6,870	*4,940	3,820	*3,820	2,540	*1,960	1,820		*1,670	*1,670	7.55 m
G.L.	kg				*6,410	*6,410	*5,730	3,610	3,890	2,430				*1,850	1,830	7.36 m
-1.5 m	kg	*4,660	*4,660	*8,910	6,450	5,900	3,530	3,840	2,390					*2,220	2,020	6.83 m
-3.0 m	kg	*7,800	*7,800	*8,350	6,550	*5,560	3,560							*3,070	2,510	5.87 m
-4.5 m	kg			*5,920	*5,920									*3,960	*3,960	4.17 m

SK130LC		Arm: 2.84 m		Bucket: without		Counterweight: 2,400 kg		Shoe: 600 mm		Dozer: blade up						
B	A	1.5 m		3.0 m		4.5 m		6.0 m		7.5 m		At max. reach		Radius		
7.5 m	kg													*2,030	*2,030	4.64 m
6.0 m	kg								*2,110	*2,110				*1,700	*1,700	6.13 m
4.5 m	kg								*2,970	2,630				*1,590	*1,590	6.98 m
3.0 m	kg				*5,270	*5,270	*3,860	*3,860	*3,330	2,530				*1,580	*1,580	7.43 m
1.5 m	kg				*7,870	6,520	*4,940	3,620	3,660	2,400	*1,960	1,710		*1,670	*1,670	7.55 m
G.L.	kg				*6,410	6,150	5,470	3,410	3,550	2,290				*1,850	1,720	7.36 m
-1.5 m	kg	*4,660	*4,660	*8,910	6,090	5,370	3,330	3,490	2,250					*2,220	1,900	6.83 m
-3.0 m	kg	*7,800	*7,800	*8,350	6,190	5,410	3,360							*3,070	2,360	5.87 m
-4.5 m	kg			*5,920	*5,920									*3,960	*3,960	4.17 m

SK130LC		Arm: 2.84 m		Bucket: without		Counterweight: 2,400 kg + 600 kg		Shoe: 600 mm		Dozer: blade up						
B	A	1.5 m		3.0 m		4.5 m		6.0 m		7.5 m		At max. reach		Radius		
7.5 m	kg													*2,030	*2,030	4.64 m
6.0 m	kg								*2,110	*2,110				*1,700	*1,700	6.13 m
4.5 m	kg								*2,970	2,890				*1,590	*1,590	6.98 m
3.0 m	kg				*5,270	*5,270	*3,860	*3,860	*3,330	2,790				*1,580	*1,580	7.43 m
1.5 m	kg				*7,870	7,200	*4,940	4,000	*3,820	2,660	*1,960	1,920		*1,670	*1,670	7.55 m
G.L.	kg				*6,410	*6,410	*5,730	3,790	3,890	2,560				*1,850	*1,850	7.36 m
-1.5 m	kg	*4,660	*4,660	*8,910	6,770	5,880	3,710	3,840	2,510					*2,220	2,120	6.83 m
-3.0 m	kg	*7,800	*7,800	*8,350	6,870	*5,560	3,740							*3,070	2,640	5.87 m
-4.5 m	kg			*5,920	*5,920									*3,960	*3,960	4.17 m

SK130LC		Arm: 2.38 m		Bucket: without		Counterweight: 2,400 kg		Shoe: 600 mm		Dozer: without						
B	A	1.5 m		3.0 m		4.5 m		6.0 m		At max. reach		Radius				
6.0 m	kg													*1,800	*1,800	5.57 m
4.5 m	kg													*1,670	*1,670	6.50 m
3.0 m	kg				*6,260	*6,260	*4,280	3,670	*3,600	2,380				*1,670	*1,670	6.98 m
1.5 m	kg				*5,420	*5,420	*5,290	3,400	3,660	2,270				*1,760	*1,760	7.11 m
G.L.	kg				*6,260	5,830	5,480	3,230	3,570	2,180				*1,990	1,800	6.91 m
-1.5 m	kg	*5,440	*5,440	*9,080	5,850	5,430	3,190	3,550	2,160					*2,460	2,020	6.34 m
-3.0 m	kg	*9,280	*9,280	*7,820	5,990	*5,270	3,260							*3,670	2,640	5.28 m

# Lift capacities

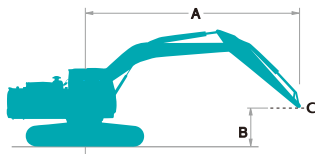

Rating over front



Rating over side or 360 degrees

A - Reach from swing centerline to arm top

B - Arm top height above/below ground

C - Lift point

Relief valve setting: 34.3 MPa













SK130LC		Arm: 2.38 m		Bucket: without		Counterweight: 2,400 kg + 600 kg		Shoe: 600 mm		Dozer: without		Radius
B	A	1.5 m		3.0 m		4.5 m		6.0 m		At max. reach		
	6.0 m	kg										
4.5 m	kg											
3.0 m	kg											
1.5 m	kg											
G.L.	kg											
-1.5 m	kg											
-3.0 m	kg											













SK130LC		Arm: 2.38 m		Bucket: without		Counterweight: 2,400 kg		Shoe: 600 mm		Dozer: blade up		Radius
B	A	1.5 m		3.0 m		4.5 m		6.0 m		At max. reach		
	6.0 m	kg										
4.5 m	kg											
3.0 m	kg											
1.5 m	kg											
G.L.	kg											
-1.5 m	kg											
-3.0 m	kg											













SK130LC		Arm: 2.38 m		Bucket: without		Counterweight: 2,400 kg + 600 kg		Shoe: 600 mm		Dozer: blade up		Radius
B	A	1.5 m		3.0 m		4.5 m		6.0 m		At max. reach		
	6.0 m	kg										
4.5 m	kg											
3.0 m	kg											
1.5 m	kg											
G.L.	kg											
-1.5 m	kg											
-3.0 m	kg											













SK130LC Two-piece		Arm: 2.84 m		Bucket: without		Counterweight: 2,400 kg		Shoe: 600 mm		Dozer: without		Radius	
B	A	1.5 m		3.0 m		4.5 m		6.0 m		7.5 m			At max. reach
	7.5 m	kg											
6.0 m	kg												
4.5 m	kg												
3.0 m	kg												
1.5 m	kg												
G.L.	kg												
-1.5 m	kg												
-3.0 m	kg												
-4.5 m	kg												













SK130LC Two-piece		Arm: 2.84 m		Bucket: without		Counterweight: 2,400 kg + 600 kg		Shoe: 600 mm		Dozer: without		Radius	
B	A	1.5 m		3.0 m		4.5 m		6.0 m		7.5 m			At max. reach
	7.5 m	kg											
6.0 m	kg												
4.5 m	kg												
3.0 m	kg												
1.5 m	kg												
G.L.	kg												
-1.5 m	kg												
-3.0 m	kg												
-4.5 m	kg												

SK130LC Two-piece		Arm: 2.84 m		Bucket: without		Counterweight: 2,400 kg		Shoe: 600 mm		Dozer: blade up				
A \ B		1.5 m		3.0 m		4.5 m		6.0 m		7.5 m		At max. reach		Radius
														
7.5 m	kg													5.37 m
6.0 m	kg								*2,750	2,690			*1,910	6.69 m
4.5 m	kg								*3,190	2,610			*1,620	7.47 m
3.0 m	kg													7.89 m
1.5 m	kg	*19,640	*19,640	*6,840	*6,840	*4,460	3,810	*2,650	2,450	2,620	1,690		*1,640	8.01 m
G.L.	kg	*14,980	*14,980	*4,280	*4,280	5,220	3,130	3,400	2,110	2,450	1,530		*1,940	7.83 m
-1.5 m	kg	*3,960	*3,960	*6,680	5,560	5,100	3,020	3,320	2,040				*2,310	7.34 m
-3.0 m	kg			*6,730	5,680	*4,790	3,050	3,340	2,060				*2,970	6.45 m
-4.5 m	kg	*13,800	*13,800	*6,600	6,080	*3,070	*3,070						*2,550	4.97 m

SK130LC Two-piece		Arm: 2.84 m		Bucket: without		Counterweight: 2,400 kg + 600 kg		Shoe: 600 mm		Dozer: blade up				
A \ B		1.5 m		3.0 m		4.5 m		6.0 m		7.5 m		At max. reach		Radius
														
7.5 m	kg													5.37 m
6.0 m	kg								*2,750	*2,750			*1,910	6.69 m
4.5 m	kg								*3,190	2,880			*1,620	7.47 m
3.0 m	kg													7.89 m
1.5 m	kg	*19,640	*19,640	*6,840	*6,740	*5,240	3,780	*3,880	2,530	2,780	1,890		*1,740	8.01 m
G.L.	kg	*14,980	*14,980	*4,280	*4,280	*5,620	3,510	3,740	2,380	2,710	1,740		*1,940	7.83 m
-1.5 m	kg	*3,960	*3,960	*6,680	6,240	*5,490	3,410	3,660	2,300				*2,310	7.34 m
-3.0 m	kg			*6,730	6,360	*4,790	3,430	*3,410	2,320				*2,970	6.45 m
-4.5 m	kg	*13,800	*13,800	*6,600	*6,600	*3,070	*3,070						*2,550	4.97 m

SK130LC Two-piece		Arm: 2.38 m		Bucket: without		Counterweight: 2,400 kg		Shoe: 600 mm		Dozer: without				
A \ B		1.5 m		3.0 m		4.5 m		6.0 m		7.5 m		At max. reach		Radius
														
7.5 m	kg													4.67 m
6.0 m	kg													6.15 m
4.5 m	kg													7.00 m
3.0 m	kg													7.45 m
1.5 m	kg													7.57 m
G.L.	kg	*15,000	*15,000	*3,990	*3,990	*5,220	2,940	3,410	1,990				*2,100	7.38 m
-1.5 m	kg			*7,360	5,340	5,150	2,880	3,360	1,950				*2,570	6.85 m
-3.0 m	kg			*6,040	5,490	*4,470	2,940						*3,100	5.90 m

SK130LC Two-piece		Arm: 2.38 m		Bucket: without		Counterweight: 2,400 kg + 600 kg		Shoe: 600 mm		Dozer: without				
A \ B		1.5 m		3.0 m		4.5 m		6.0 m		7.5 m		At max. reach		Radius
														
7.5 m	kg													4.67 m
6.0 m	kg													6.15 m
4.5 m	kg													7.00 m
3.0 m	kg													7.45 m
1.5 m	kg													7.57 m
G.L.	kg	*15,000	*15,000	*3,990	*3,990	*5,690	3,320	3,750	2,260				*2,100	7.38 m
-1.5 m	kg			*7,360	6,020	*5,390	3,260	3,700	2,210				*2,570	6.85 m
-3.0 m	kg			*6,040	*6,040	*4,470	3,320						*3,100	5.90 m

SK130LC Two-piece		Arm: 2.38 m		Bucket: without		Counterweight: 2,400 kg		Shoe: 600 mm		Dozer: blade up				
A \ B		1.5 m		3.0 m		4.5 m		6.0 m		7.5 m		At max. reach		Radius
														
7.5 m	kg													4.67 m
6.0 m	kg													6.15 m
4.5 m	kg													7.00 m
3.0 m	kg													7.45 m
1.5 m	kg													7.57 m
G.L.	kg	*15,000	*15,000	*3,990	*3,990	5,210	3,120	3,400	2,120				*2,100	7.38 m
-1.5 m	kg			*7,360	5,660	5,140	3,060	3,350	2,070				*2,570	6.85 m
-3.0 m	kg			*6,040	5,810	*4,470	3,120						*3,100	5.90 m

SK130LC Two-piece		Arm: 2.38 m		Bucket: without		Counterweight: 2,400 kg + 600 kg		Shoe: 600 mm		Dozer: blade up				
B	A	1.5 m		3.0 m		4.5 m		6.0 m		7.5 m		At max. reach		
														Radius
7.5 m	kg					*2,590	*2,590					*2,070	*2,070	4.67 m
6.0 m	kg							*2,370	*2,370			*1,790	*1,790	6.15 m
4.5 m	kg					*4,010	*4,010	*2,960	2,840			*1,710	*1,710	7.00 m
3.0 m	kg			*7,610	7,370	*4,780	4,100	*3,100	2,680			*1,740	*1,740	7.45 m
1.5 m	kg			*8,870	6,600	*5,470	3,720	*3,550	2,510	*2,340	1,810	*1,860	1,780	7.57 m
G.L.	kg	*15,000	*15,000	*3,990	*3,990	*5,690	3,510	3,740	2,390			*2,100	1,800	7.38 m
-1.5 m	kg			*7,360	6,340	*5,390	3,450	3,690	2,340			*2,570	1,970	6.85 m
-3.0 m	kg			*6,040	*6,040	*4,470	3,510					*3,100	2,460	5.90 m

**Note:**

- Do not attempt to lift or hold any load that is greater than these lift capacities at their specified lift point radius and heights. Weight of all accessories must be deducted from the above lift capacities.
- Lift capacities are based on machine standing on level, firm, and uniform ground. User must make allowance for job conditions such as soft or uneven ground, out of level conditions, side loads, sudden stopping of loads, hazardous conditions, experience of personnel, etc.
- Bucket pin attachment point defined as lift point.
- The above lift capacities are in compliance with ISO 10567. They do not exceed 87% of hydraulic lift capacity or 75% of tipping load. Lift capacities marked with an asterisk (\*) are limited by hydraulic capacity rather than tipping load.
- Operator should be fully acquainted with the Operator's and Maintenance Instructions before operating this machine. Rules for safe operation of equipment should be adhered to at all times.
- Lift capacities apply to only machine as originally manufactured and normally equipped by KOBELCO CONSTRUCTION MACHINERY CO., LTD.

## STANDARD EQUIPMENT

### ENGINE

- Engine, ISUZU MOTORS LIMITED 4JJ1XDDV A01, Diesel engine with turbocharger and intercooler, EU Stage V compliant
- Auto Idle Stop
- Automatic engine deceleration
- Batteries (2 x 12 V - 88 Ah)
- Starting motor (24 V - 4 kW), 50 amp alternator
- Engine oil pan drain cock
- Double element air cleaner
- Refuelling pump

### CONTROL

- Working mode selector (H-mode, S-mode and ECO-mode)
- N&B piping (proportional hand controlled)
- Extra piping (proportional hand controlled)
- Boom, arm safety valves and overload alarm

### SWING SYSTEM & TRAVEL SYSTEM

- Swing rebound prevention system
- Straight propel system
- Two-speed travel with automatic shift down
- Sealed & lubricated track links
- 600 mm HD shoes
- Grease-type track adjusters
- Automatic swing brake
- Lower Frame Guard

### MIRRORS, LIGHTS & CAMERAS

- Rear view mirror, rear view camera and right side view camera
- Three front working lights (LED)

## OPTIONAL EQUIPMENT

- Various optional arms
- Wide range of shoes
- Front-guard protective structure (may interfere with bucket action)
- Heavier counterweight (+ 600 kg)
- Cab top work LED lights (two lights)
- Mechanical suspension seat (Applicable for N&B piping)

Note: Standard and optional equipment may vary. Consult your KOBELCO dealer for specifics.

Bluetooth\* is a registered trademark of the Bluetooth SIG Inc.

### CAB & CONTROL

- Two control levers, pilot-operated
- Horn, electric
- Integrated left-right slide-type control box
- LED door light (interior)
- Coat hook
- Large cup holder
- Detachable two-piece floor mat
- GRAMMER air suspension seat with heater
- Retractable seatbelt
- Headrest
- Handrails
- Intermittent parallel wiper with double-spray washer
- Skylight
- Openable top guard (ISO 10262: 1998)
- Tinted safety glass
- Pull-type front window and removable lower front window
- Easy-to-read 10-inch LCD SCREEN multi-display monitor
- Automatic air conditioner
- Emergency escape hammer
- Radio (AUX & Bluetooth\*)
- 12 V converter
- Hands-free telephone
- USB port

- Rain visor (may interfere with bucket action)
- Quick hitch piping
- Eagle eye view
- Dozer blade
- Roll sun shade
- Travel alarm

Note: This catalogue may contain attachments and optional equipment that are not available in your area. And it may contain photographs of machines with specifications that differ from those of machines sold in your areas. Please consult your nearest KOBELCO distributor for those items you require. Due to our policy of continuous product improvements all designs and specifications are subject to change without advance notice.

Copyright by **KOBELCO CONSTRUCTION MACHINERY CO., LTD.** No part of this catalogue may be reproduced in any manner without notice.

## KOBELCO CONSTRUCTION MACHINERY EUROPE B.V.

Veluwezoom 15  
1327 AE Almere  
The Netherlands  
www.kobelco-europe.com

Enquiries To: