

KOBELCO

SK350LC-10E/SK350NLC-10E

SK350_{LC} SK350_{NLC}

■ Bucket Capacity:

1.2 - 1.8 m³

■ Engine Power:

213 kW / 2,100 min⁻¹

■ Operating Weight:

36,300 - 39,300 kg



Complies with the EU Stage V
exhaust emission regulation

We Save You Fuel
Achieving a Low-Carbon Society

Power Meets Efficiency



SK350_{LC} SK350_{NLC}

10%
Higher fuel efficiency
means
"Efficiency"

Increase in
productivity
means "Power"

Compared to S-mode on the SK350LC-9

To urban centers, and to mines around the world. Kobelco's all-out innovation brings you durable earth-friendly construction machinery that's equal to any task, at sites all over the planet. Increased power and even greater fuel economy bring higher efficiency to any project. Kobelco SK350LC machines are also more durable than ever, able to withstand the rigors of the toughest job sites. It all adds up to new levels of value that are a step ahead of the times. Also, this machine conforms to Stage V Exhaust Emission Standards, thanks to its significantly reduced NOx* emissions. While focusing on the global environment of the future, Kobelco offers next-generation productivity to meet the need for lower life cycle costs and exceed the expectations of customers the world over.

* NOx: Nitrogen Oxide

JAPANESE QUALITY



Evolution Continues, with Improved Fuel Efficiency

Hydraulic System: Revolutionary Technology Saves Fuel **NEW**

Arm Interflow System

When lowering the boom, this system uses the downward force generated by the boom's weight to push fluid to the shovel arm. This greatly reduces the need to apply power from outside the system.

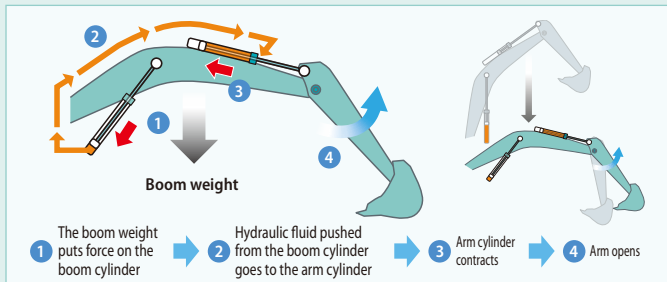

Hydraulic circuit reduces energy loss

We have made every effort to enhance fuel efficiency by minimizing hydraulic pressure resistance, improving the hydraulic line layout to control friction resistance loss and minimizing valve resistance.

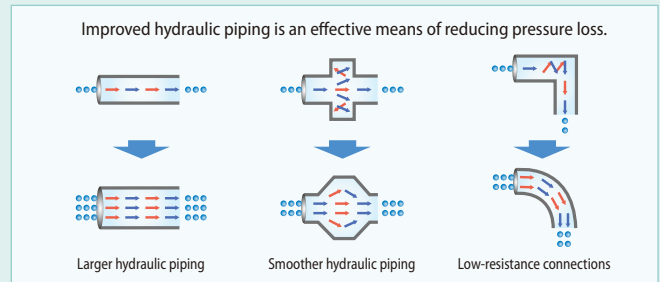

In Pursuit of Improved Fuel Efficiency

Operation Mode

Fuel consumption is lower in ECO-mode/S-mode in comparison with the previous model (Generation 9).

■ Compared to previous models



E ECO-mode
... About **9%** improvement

S S-mode
... About **10%** improvement

Always and Forever. Yesterday, Today, and Tomorrow. We're Obsessed with Fuel Efficiency.

Over the past 10 years, KOBELCO has achieved an average fuel consumption reduction of 47% across its fleet. We vow to lead the industry in improving fuel efficiency.

■ Compared to SK350LC-6 model (2006)

E ECO-mode (SK350LC-10E)
... About **47%** improvement

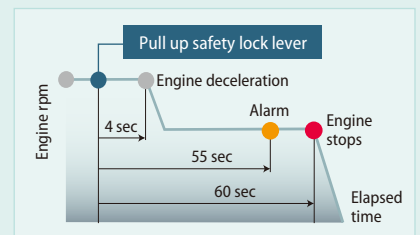

AIS (Auto Idle Stop)

If the boarding/disembarking lever is left up, the engine will stop automatically. This eliminates wasteful idling during standby, saving fuel and reducing CO₂ emissions as well.



10%
Higher fuel efficiency
means
"Efficiency"

The new arm interflow system more efficiently controls hydraulic fluid flow, and significant reduction of in-line resistance and pressure loss boosts fuel efficiency by about 10%*1. The engine, already well-known for its environmental performance has a new SCR*2 system, and its reduced NOx emissions means the engine now meets Stage V Standards.

*1 Compared to S-mode on the SK350LC-9
*2 SCR: Selective Catalytic Reduction

Engine Meets Stage V Standards

Reduces Fuel Consumption and Minimizes Exhaust Emissions

Hino engines are renowned for fuel efficiency and environmental performance, and Kobelco has tuned these powerplants especially for construction machinery. The pressure within the common rail fuel injection system, the VG turbo, and the exhaust gas after-treatment system reduce exhaust PM*3 while the large-capacity EGR cooler sharply reduces the formation of NOx gases.



*3 PM: Particulate Matter

SCR System with DEF/Urea NEW

The engine exhaust system has an SCR system that converts NOx emissions into harmless nitrogen and water. Combining this with a post-exhaust gas treatment system that captures and disposes of PM, the SK350LC has a much cleaner exhaust that meets Stage V exhaust emission standards.

■ NOx reduction rate
(Compared to previous models)

About **80%** decrease

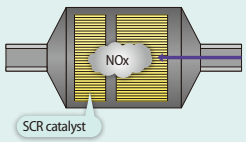

VG Turbo Reduces PM

The variable-geometry turbocharger adjusts air intake to maximize combustion efficiency. At low engine speeds the nozzles are closed, the turbo speed increased and air intake is boosted. This helps lower fuel consumption.

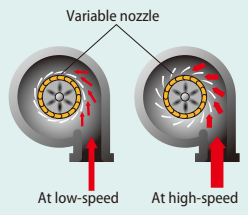

EGR Cooler Reduces NOx

Cooled exhaust gases from the EGR cooler are mixed with fresh air in the intake. The recirculated air lowers the combustion temperature which reduces NOx.

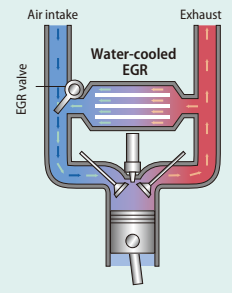

More Power and Higher Efficiency

The highly efficient hydraulic system minimizes fuel consumption while maximizing power. With nimble movement and ample digging power, this excavator promises to improve your job productivity.

Improved fuel efficiency contributes to high performance

Superior Digging Volume

This excavator offers dynamic digging force even as it minimizes fuel consumption rates, achieving class-leading work volume. H-mode with an increased torque setting delivers about 5% greater digging volume.

■ Digging volume/hour
(Compared to H-mode on previous models)



■ Max. Bucket Digging Force

Normal: **222 kN**

With Power Boost: **244 kN**

■ Max. Arm Crowding Force

Normal: **163 kN**

With Power Boost: **180 kN**

*Values are for HD arm (3.30 m)



Get More Done Faster with Superior Operability

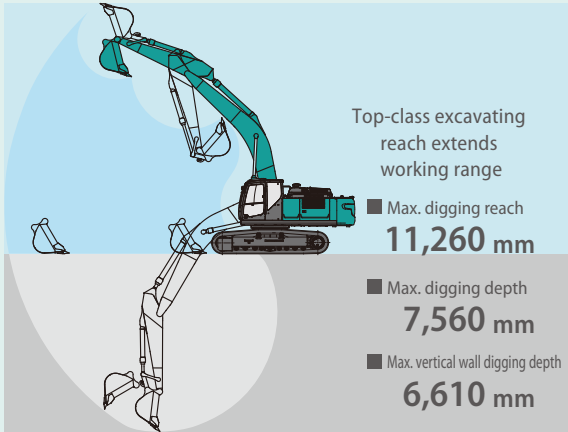

*Values are for HD arm (3.30 m)

Piping for Quick Hitch



A quick hitch hydraulic line, which speeds up attachment changes, is available as a standard.

A Light Touch on the Lever Means Smoother, Less Tiring Work

NEW



It takes 25% less effort to work the operation lever, which reduces fatigue over long working hours or continued operations.

Top Class Traveling Force

Powerful traveling force and pulling force deliver plenty of speed when climbing slopes or negotiating bad roads, and the agility to change direction swiftly and smoothly.



■ Drawbar Pulling Force: **332kN**

Operator-friendly Features Include Controls that Are Easy to See, Easy to Use



Multi-Display in Color

Brilliant colors and graphic displays are easy to recognize on the LCD multi-display in the console. The display shows fuel consumption, maintenance intervals, and more.

- 1 Analog gauge provides an intuitive reading of fuel level and engine water temperature
- 2 Green indicator light shows low fuel consumption during operation
- 3 PM accumulation display (left)/Urea level gauge (right)
- 4 Fuel consumption/Switch indicator for rear camera images
- 5 Digging mode switch
- 6 Monitor display switch

One-Touch Attachment Mode Switch

A simple flick of a switch converts the hydraulic circuit and flow amount to match attachment changes. Icons help the operator to confirm the proper configuration at a glance.



PM accumulation/
Urea accumulation display



Fuel consumption



Maintenance

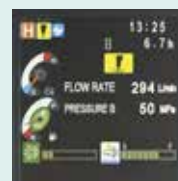

Breaker mode

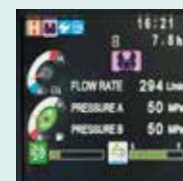

Nibbler mode

Increased Power, with Enhanced Durability to Maintain the Machine's Value

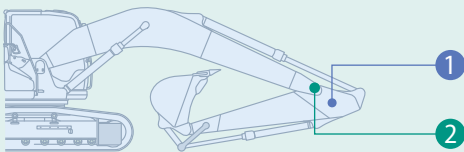

Built to Operate in Tough Working Environments

The attachment has been reinforced to handle a higher work volume, with greater power and excellent durability that can withstand demanding work conditions.

1 Enlarged Reinforcement of the Arm Foot **NEW**

HD: Base plate thickness has been increased 1.3 times.



Current

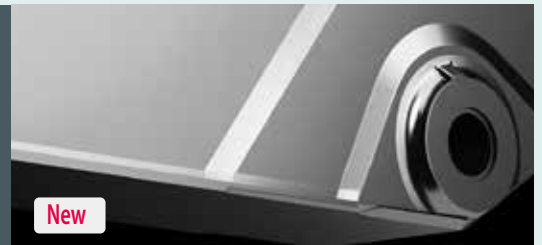

New

2 Modified Foot Boss Shape **NEW**

The arm foot boss shape has been modified and improved to distribute stress, delivering 2.6 times more strength for tasks like digging next to a wall.

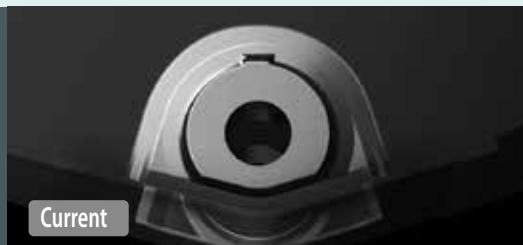

Current

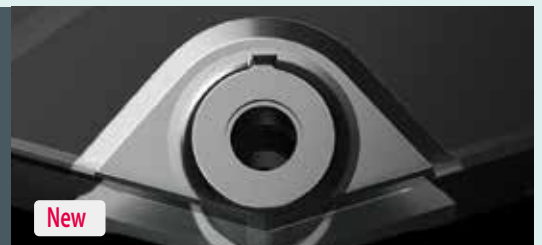

New

Increase in productivity means "Power"

Structural design increases strength, while eliminating hydraulic problems. Enhanced durability takes productivity to a new level.



Improved Filtration System Reliability

Clean, contaminant-free fuel and hydraulic fluid are essential to stable performance. The improved filtration systems reduce the risk of mechanical trouble and enhance longevity and durability.

Hydraulic Fluid Filter **NEW**

Recognized as the best in the industry, our super-fine filter separates out even the smallest particles. New cover prevents contamination when changing filters.



Hydraulic Fluid Filter Clog Detector **NEW**

Pressure sensors at the inlet and outlet of the hydraulic fluid filter monitor differences in pressure to determine the degree of clogging. If the difference in pressure exceeds a predetermined level, a warning appears on the multi-display, so any contamination can be removed from the filter before it reaches the hydraulic fluid reservoir.

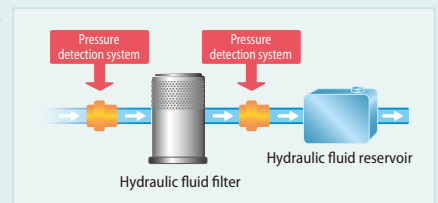

Double-Element Air Cleaner

The large-capacity element features a double-filter structure that keeps the engine running clean even in industrial environments.



Fuel Filter **NEW**

The pre-filter, with built-in water separator maximizes filtering performance.

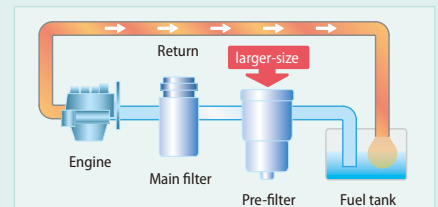

Comfortable Cab Is Now Safer than Ever

A work environment that is quieter and more comfortable. A cab that puts the operator first is key to improved safety.



Comfort

Super-Airtight Cab



The high level of air-tightness keeps dust out of the cab.

Quiet Inside

The high level of air-tightness ensures a quiet, comfortable cabin interior.

Low Vibration

Coil springs absorb small vibrations, and high suspension mounts filled with silicone oil reduce heavy vibration. The long stroke achieved by this system provides excellent protection from vibration.

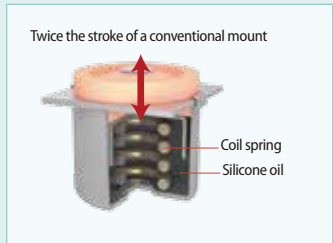

Broad View Liberates the Operator

The front window features one large piece of glass without a center pillar on the right side for a wide, unobstructed view.

Air Conditioner Register behind the Seat **NEW**



The large air-conditioner has registers on the back pillars that blow from behind and to the right and left of the operator's seat. They can be adjusted to put a direct flow of cool/warm air on the operator, which means a more comfortable operating environment.

More Comfortable Seat Means Higher Productivity



Seat suspension absorbs vibration



Seat recliner can be pushed back flat



Double slides allow adjustment for optimum comfort



Large Cab Is Easy to Get in and out of

The expanded cab provides plenty of room for a large door, more headroom and smoother entry and exit.

Interior Equipment Adds to Comfort and Convenience



Automatic AM/FM radio



USB pin/24V power outlet



Spacious storage tray



Large cup holder

Safety

ROPS Cab

ROPS (Roll-Over-Protective Structure)-compliant cab clears ISO standards (ISO-12117-2: 2008) and ensures greater safety for the operator should the machine tip over.



TOP Guard (Level II) is fitted as standard.

Expanded Field of View for Greater Safety



Rear View Camera

Right side View Camera

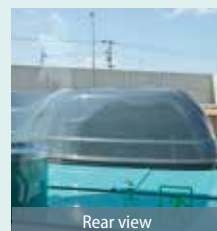

Rear view

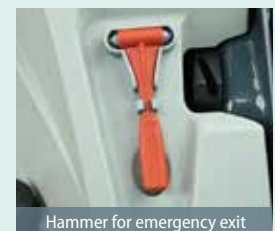

Hammer for emergency exit

Right Side Camera Fitted as Standard

Further to the existing rear-view camera, a camera for the right side is fitted as standard for easy safety checks all round the machine.

Rear view shows the area directly behind the cab.

KOMEXS

KOBELCO MONITORING EXCAVATOR SYSTEM



Remote Monitoring for Peace of Mind

KOMEXS (Kobelco Monitoring Excavator System) uses satellite communication and internet to relay data, and therefore can be deployed in areas where other forms of communication are difficult. When a hydraulic excavator is fitted with this system, data on the machine's operation, such as operating hours, location, fuel consumption, and maintenance status can be obtained remotely.

Direct Access to Operational Status

Location Data

Accurate location data can be obtained even from sites where communications are difficult.



Latest location

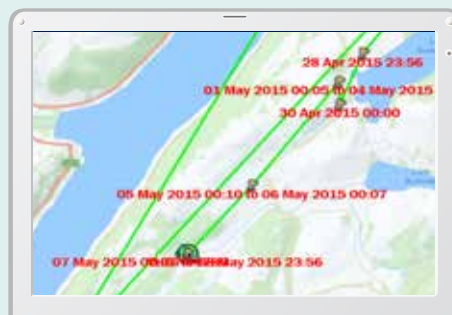

Location records

Type of Operation	Working Hrs	Ratio
Total Working Hrs	169 Hrs	100 %
Digging Hrs	72.2 Hrs	43 %
Traveling Hrs	18.3 Hrs	11 %
Idle Hrs	15.9 Hrs	9 %
Opt Att Hrs	62.5 Hrs	37 %
Crane Mode Hrs	0 Hrs	0 %

Work data

Operating Hours

- A comparison of operating times of machines at multiple locations shows which locations are busier and more profitable.
- Operating hours on site can be accurately recorded, for running time calculations needed for rental machines, etc.

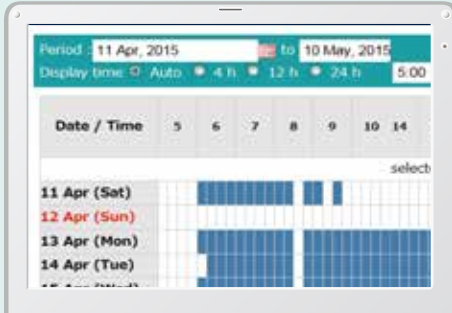

Daily report

Fuel Consumption Data

Data on fuel consumption and idling times can be used to indicate improvements in fuel consumption.

Work mode	Working Hrs	Total Fuel Consumption
H mode	2:06	24.5 L
S mode	0:00	0.0 L
E mode	169:19	1489.7 L
TOTAL	171:25	1514.2 L

Fuel consumption

Graph of Work Content

The graph shows how working hours are divided among different operating categories, including digging, idling, traveling and optional operations.

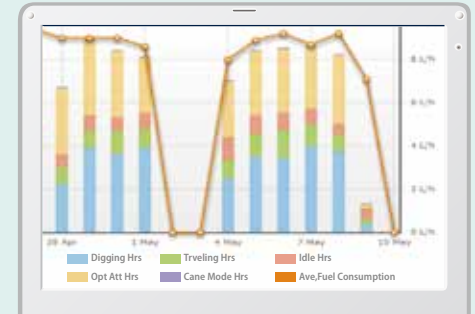

Work status

Maintenance Data and Warning Alerts

Machine Maintenance Data

- Provides maintenance status of separate machines operating at multiple sites.
- Maintenance data is also relayed to KOBELCO service personnel, for more efficient planning of periodic servicing.

Model	Serial No.	Hour Meter	Engine Oil
SK135SRLC-3/SK140SRL	YH07-09221	734 Hr	434
SK135SRLC-3/SK140SRL	YH07-09289	73 Hr	429
SK210LC-9	YQ13-10454	960 Hr	58
SK210LC-9	YQ13-10481	549 Hr	498
SK75SR-	YT08-20374		

Maintenance

Warning Alerts

This system warns an alert if an anomaly is sensed, preventing damage that could result in machine downtime.

Alarm Information Can Be Received through E-mail

Alarm information or maintenance notice can be received through E-mail, using a computer or cell phone.



Alarm messages can be received on mobile device.

Daily/Monthly Reports

Operational data downloaded onto a computer helps in formulating daily and monthly reports.

Security System

Engine Start Alarm

The system can be set as an alarm if the machine is operated outside designated time.

Engine start alarm outside prescribed work time

Area Alarm

It can be set as an alarm if the machine is moved out of its designated area to another location.

Alarm for outside of reset area



Easy, On-the-Spot Maintenance NEW

There is ample space in the engine compartment for a mechanic to do maintenance work inside. The distance between steps is lower so entry and exit is easier. And the mechanic can work in comfort, without contortions or unnatural body positions. Finally, the hood is lighter and easier to raise and lower.



Generous space for maintenance work



Step/Hand rail



DEF/Urea tank



Double-element air cleaner

Positioned where the step opens

Maintenance Work, Daily Checks, Etc., Can Be Done from Ground Level

The layout allows for easy access from the ground for many daily checks and regular maintenance tasks.



Fuel filter/Pre-filter



Right side



Engine oil filter

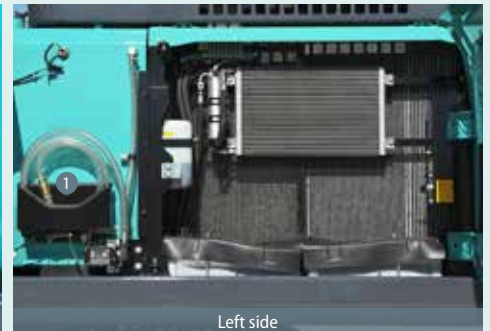

Left side

- ① Fuel filter
- ② Pre-filter
- ③ Engine oil filter

Laid out for easy access to radiator and cooling system elements

- ① Refueling pump

Efficient Maintenance Keeps the Machine in Peak Operating Condition



MAINTENANCE			
	INTERVAL	REMAINING TIME	EXCHANGE DAY
ENGINE OIL	500 _h	495 _h	--/--/--
FUEL FILTER	500 _h	495 _h	--/--/--
HYD. FILTER	1000 _h	995 _h	--/--/--
HYD. OIL	5000 _h	4995 _h	--/--/--

6.7h

Machine Information Display Function

Examples of displaying maintenance information

- Displays only the maintenance information that's needed, when it's needed
- Self-diagnostic function provides early-warning detection and display of electrical system malfunctions
- Service-diagnostic function makes it easier to check the status of the machine
- Record function of previous breakdowns including irregular and transient malfunction

More Efficient Maintenance Inside the Cab



Easy-access fuse box

More finely differentiated fuses make it easier to locate malfunctions.



Air conditioner filters

Internal and external air conditioner filters can be easily removed without tools for cleaning.



DPF reactivation switch

If the monitor warning goes off, the filter should be reactivated manually using a switch.

Easy Cleaning



Crawler frame

Special crawler frame design is easily cleaned of mud.



Detachable two-piece floor mat

Detachable two-piece floor mat with handles for easy removal. A floor drain is located under floor mat.



Engine oil pan

Engine oil pan equipped with drain valve.

Long-life hydraulic oil:
5,000
hours

Long-Interval Maintenance

Long-life hydraulic oil reduces cost and labor.

Replacement cycle:
1,000
hours

Highly Durable Super-fine Filter

The high-capacity hydraulic oil filter incorporates glass fiber with superior cleaning power and durability.





Engine

Model	HINO J08EYD-KSDA
Type	Direct injection, water-cooled, 4-cycle diesel engine with turbocharger, intercooler, complies with EU Stage V exhaust emission regulation
No. of cylinders	6
Bore and stroke	112 mm x 130 mm
Displacement	7.684 L
Rated power output	201 kW/2,100 min ⁻¹ (ISO 9249)
	213 kW/2,100 min ⁻¹ (ISO 14396)
Max. torque	988 N·m/1,600 min ⁻¹ (ISO 9249)
	1,017 N·m/1,600 min ⁻¹ (ISO 14396)



Hydraulic System

Pump	
Type	Two variable displacement pumps + one gear pump
Max. discharge flow	2 x 294 L/min, 1 x 21 L/min
Relief valve setting	
Boom, arm and bucket	34.3 MPa {350 kgf/cm ² }
Power Boost	37.8 MPa {385 kgf/cm ² }
Travel circuit	34.3 MPa {350 kgf/cm ² }
Swing circuit	29.0 MPa {296 kgf/cm ² }
Control circuit	5.0 MPa {50 kgf/cm ² }
Pilot control pump	Gear type
Main control valve	8-spool
Oil cooler	Air cooled type



Swing System

Swing motor	Axial piston motor
Brake	Hydraulic; locking automatically when the swing control lever is in neutral position
Parking brake	Oil disc brake, hydraulic operated automatically
Swing speed	10.0 min ⁻¹ {rpm}
Swing torque	119.6 kN·m



Attachments

Backhoe bucket and combination

Use	Backhoe bucket					
		Normal digging		Light-duty		
Bucket capacity	ISO heaped	m ³	1.2	1.4	1.6	1.8
	Struck	m ³	0.84	1.0	1.2	1.4
Opening width	With side cutter	mm	1,240	1,420	1,570	–
	Without side cutter	mm	1,110	1,300	1,450	1,680
No. of teeth			4	5	5	5
Bucket weight		kg	930	1,070	1,100	1,200
Combination	2.6 m short arm		○	○	◎	△
	3.3 m standard arm		○	◎	△	×
	4.15 m long arm		◎	△	×	×

◎ Standard ○ Recommended △ Loading only × Not recommended



Travel System

Travel motors	2 x axial-piston, two-step motors
Travel brakes	Hydraulic brake per motor
Parking brakes	Oil disc brake per motor
Travel shoes	48 each side
Travel speed	5.6/3.3 km/h
Drawbar pulling force	332 kN (ISO 7464)
Gradeability	70 % {35°}



Cab & Control

Cab	
All-weather, sound-suppressed steel cab mounted on the high suspension mounts filled with silicone oil and equipped with a heavy, insulated floor mat.	
Control	
Two hand levers and two foot pedals for travel	
Two hand levers for excavating and swing	
Electric rotary-type engine throttle	
Noise levels	
External	105dB(A) (ISO 6395)
Operator	69dB(A) (ISO 6396)



Boom, Arm & Bucket

Boom cylinders	140 mm x 1,550 mm
Arm cylinder	170 mm x 1,788 mm
Bucket cylinder	150 mm x 1,193 mm



Refilling Capacities & Lubrications

Fuel tank	503 L
Cooling system	35 L
Engine oil	28.5 L
Travel reduction gear	2 x 8.0 L
Swing reduction gear	7.4 L
Hydraulic oil tank	245 L tank oil level
	410 L hydraulic system
DEF/Urea tank	83 L



Working Ranges

Unit: m

Range	Arm	6.5 m Boom		
		Short 2.6 m	Standard 3.3 m	Long 4.15 m
a- Max. digging reach		10.61	11.26	11.97
b- Max. digging reach at ground level		10.4	11.06	11.79
c- Max. digging depth		6.86	7.56	8.41
d- Max. digging height		10.26	10.58	10.7
e- Max. dumping clearance		7.06	7.37	7.53
f- Min. dumping clearance		3.32	2.62	1.77
g- Max. vertical wall digging depth		5.84	6.61	7.15
h- Min. swing radius		4.45	4.31	4.43
i- Horizontal digging stroke at ground level		4.21	5.82	7.21
j- Digging depth for 2.4 m (8') flat bottom		6.67	7.4	8.27
Bucket capacity ISO heaped m ³		1.6	1.4	1.2

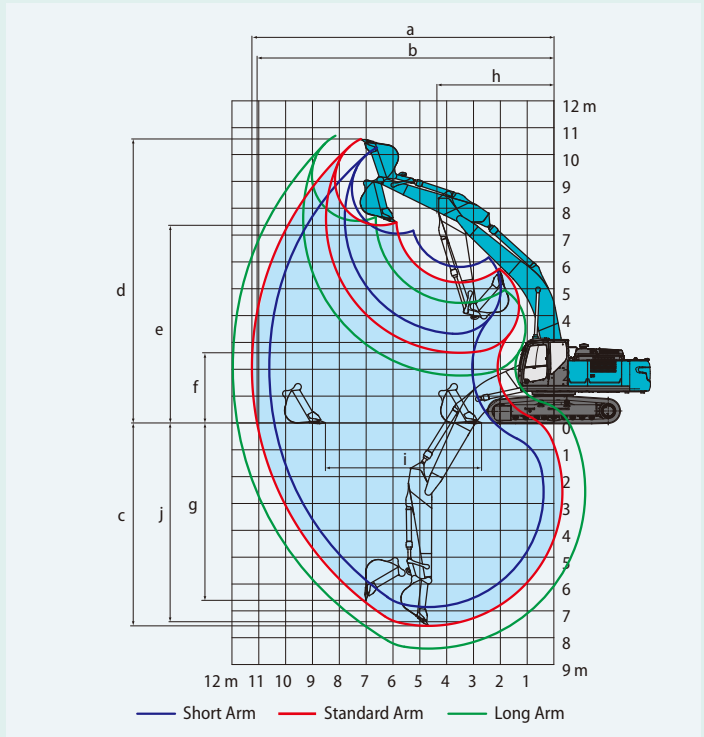

Digging Force (ISO 6015)

Unit: kN

Arm length	Short 2.6 m	Standard 3.3 m	Long 4.15 m
Bucket digging force	222 244*	222 244*	222 244*
Arm crowding force	205 225*	163 180*	140 154*

*Power Boost engaged



Dimensions

Arm length		Short 2.6 m	Standard 3.3 m	Long 4.15 m
A Overall length		11,380	11,300	11,330
B Overall height (to top of boom)		3,680	3,420	3,590
C Overall width of crawler	SK350LC	3,190		
	SK350NLC	2,990		
D Overall height (to top of cab)		3,200		
E Ground clearance of rear end*		1,190		
F Ground clearance*		500		
G Tail swing radius		3,600		

Unit: mm

G' Distance from center of swing to rear end		3,600
H Tumbler distance		4,050
I Overall length of crawler		4,960
J Track gauge	SK350LC	2,590
	SK350NLC	2,390
K Shoe width		600
L Overall width of upperstructure		2,980

*Without including height of shoe

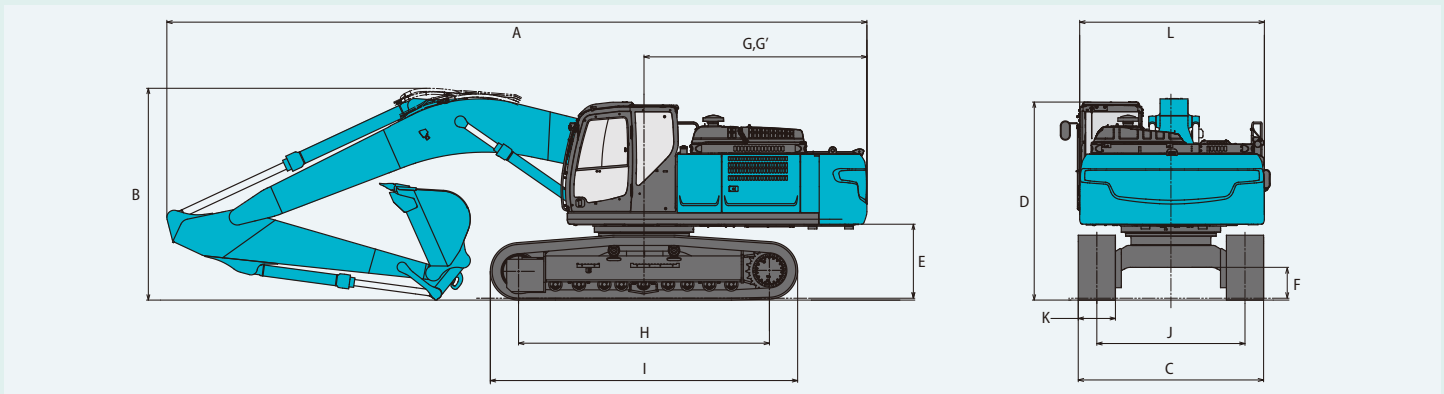

Operating Weight & Ground Pressure

In standard trim, with standard boom, 3.3 m arm, and 1.4 m³ ISO heaped bucket.

Shaped		Double grouser shoes	Triple grouser shoes (even height)				
			600	700	800	900	
Shoe width	mm	600	600	700	800	900	
Overall width of crawler	SK350LC	mm	3,190	3,190	3,290	3,390	3,490
	SK350NLC	mm	2,990	2,990	3,090	-	-
Ground pressure	SK350LC	kPa	69	68	60	53	47
	SK350NLC	kPa	69	68	60	-	-
Operating weight	SK350LC	kg	37,000	36,400	37,200	37,600	38,000
	SK350NLC	kg	36,900	36,300	37,200	-	-

Lift Capacities

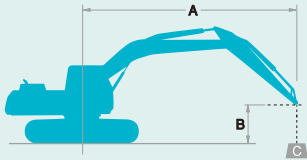

Rating over front



Rating over side or 360 degrees

A: Reach from swing centerline to arm top
 B: Arm top height above/below ground
 C: Lifting capacities in Kilograms
 Bucket: Without bucket
 Relief valve setting: 37.8 MPa (385 kgf/cm²)

SK350LC		Boom: 6.5 m		Arm: 3.3 m		Bucket: without		Shoe: 600 mm (Heavy Lift)								
B	A	1.5 m		3.0 m		4.5 m		6.0 m		7.5 m		9.0 m		At Max. Reach	Radius	
9.0 m	kg													*6,370	*6,370	6.56 m
7.5 m	kg									*7,810	*7,810			*5,840	*5,840	7.86 m
6.0 m	kg									*7,930	*7,930			*5,640	*5,640	8.71 m
4.5 m	kg							*9,720	*9,720	*8,490	7,700	*7,850	5,750	*5,650	5,480	9.25 m
3.0 m	kg					*15,090	*15,090	*11,160	10,160	*9,230	7,360	*8,160	5,600	*5,830	5,110	9.52 m
1.5 m	kg					*17,300	14,250	*12,430	9,580	*9,940	7,040	8,400	5,430	*6,200	4,980	9.54 m
G.L.	kg					*18,060	13,770	*13,170	9,200	*10,400	6,810	8,270	5,320	*6,830	5,070	9.33 m
-1.5 m	kg			*15,390	*15,390	*17,700	13,670	*13,230	9,040	*10,420	6,700			*7,890	5,410	8.85 m
-3.0 m	kg	*17,520	*17,520	*22,280	*22,280	*16,380	13,810	*12,490	9,080	*9,690	6,750			*8,640	6,160	8.07 m
-4.5 m	kg			*18,200	*18,200	*13,800	*13,800	*10,490	9,330					*8,540	7,810	6.88 m

SK350LC		Boom: 6.5 m		Arm: 4.15 m		Bucket: without		Shoe: 600 mm (Heavy Lift)								
B	A	1.5 m		3.0 m		4.5 m		6.0 m		7.5 m		9.0 m		At Max. Reach	Radius	
9.0 m	kg									*5,080	*5,080			*4,770	*4,770	7.56 m
7.5 m	kg													*4,460	*4,460	8.71 m
6.0 m	kg									*6,890	*6,890	*6,580	5,910	*4,350	*4,350	9.49 m
4.5 m	kg									*7,520	*7,520	*6,990	5,760	*4,380	*4,380	9.98 m
3.0 m	kg			*21,160	*21,160	*13,040	*13,040	*9,950	*9,950	*8,350	7,380	*7,420	5,550	*4,530	4,480	10.23 m
1.5 m	kg					*15,760	14,500	*11,410	9,620	*9,190	6,990	*7,880	5,330	*4,820	4,350	10.25 m
G.L.	kg			*10,820	*10,820	*17,290	13,670	*12,470	9,100	*9,850	6,670	8,120	5,150	*5,280	4,390	10.05 m
-1.5 m	kg	*10,180	*10,180	*14,950	*14,950	*17,630	13,340	*12,920	8,810	*10,150	6,480	8,010	5,050	*6,040	4,620	9.62 m
-3.0 m	kg	*14,870	*14,870	*20,400	*20,400	*16,950	13,330	*12,670	8,740	*9,910	6,430			*7,340	5,150	8.91 m
-4.5 m	kg	*20,310	*20,310	*21,170	*21,170	*15,190	13,570	*11,490	8,870	*8,720	6,570			*8,060	6,210	7.85 m
-6.0 m	kg			*15,790	*15,790	*11,710	*11,710	*8,510	*8,510					*7,910	*7,910	6.26 m

SK350LC		Boom: 6.5 m		Arm: 2.6 m		Bucket: without		Shoe: 600 mm (Heavy Lift)				
B	A	3.0 m		4.5 m		6.0 m		7.5 m		At Max. Reach		Radius
7.5 m	kg									*8,760	8,640	7.06 m
6.0 m	kg					*9,360	*9,360	*8,610	7,750	*8,540	8,930	8.00 m
4.5 m	kg			*13,460	*13,460	*10,470	*10,470	*9,030	7,510	*8,510	6,060	8.58 m
3.0 m	kg					*11,770	9,860	*9,650	7,200	*8,600	5,610	8.87 m
1.5 m	kg					*12,800	9,350	*10,200	6,920	8,480	5,460	8.89 m
G.L.	kg			*17,830	13,610	*13,230	9,070	*10,460	6,740	8,720	5,590	8.66 m
-1.5 m	kg			*16,930	13,660	*12,940	9,000	*10,170	6,700	*9,090	6,050	8.15 m
-3.0 m	kg	*19,180	*19,180	*15,120	13,900	*11,730	9,140			*9,110	7,120	7.29 m
-4.5 m	kg	*14,570	*14,570	*11,740	*11,740					*8,590	*8,590	5.95 m

SK350NLC		Boom: 6.5 m Arm: 3.3 m Bucket: without Shoe: 600 mm (Heavy Lift)														
B \ A		1.5 m		3.0 m		4.5 m		6.0 m		7.5 m		9.0 m		At Max. Reach		Radius
9.0 m	kg													*6,370	*6,370	6.56 m
7.5 m	kg									*7,810	7,500			*5,840	*5,840	7.86 m
6.0 m	kg									*7,930	7,400			*5,640	*5,640	8.71 m
4.5 m	kg							*9,720	*9,720	*8,490	7,140	*7,850	5,320	*5,650	5,070	9.25 m
3.0 m	kg					*15,090	14,020	*11,160	9,360	*9,230	6,800	*8,160	5,170	*5,830	4,720	9.52 m
1.5 m	kg					*17,300	12,960	*12,430	8,800	*9,940	6,490	8,370	5,010	*6,200	4,590	9.54 m
G.L.	kg					*18,060	12,500	*13,170	8,430	*10,400	6,260	8,240	4,890	*6,830	4,660	9.33 m
-1.5 m	kg			*15,390	*15,390	*17,700	12,400	*13,230	8,270	*10,420	6,150			*7,890	4,980	8.85 m
-3.0 m	kg	*17,520	*17,520	*22,280	*22,280	*16,380	12,530	*12,490	8,310	*9,690	6,200			*8,640	5,670	8.07 m
-4.5 m	kg			*18,200	*18,200	*13,800	12,880	*10,490	8,560					*8,540	7,190	6.88 m

SK350NLC		Boom: 6.5 m Arm: 4.15 m Bucket: without Shoe: 600 mm (Heavy Lift)														
B \ A		1.5 m		3.0 m		4.5 m		6.0 m		7.5 m		9.0 m		At Max. Reach		Radius
9.0 m	kg									*5,080	*5,080			*4,770	*4,770	7.56 m
7.5 m	kg													*4,460	*4,460	8.71 m
6.0 m	kg									*6,890	*6,890	*6,580	5,470	*4,350	*4,350	9.49 m
4.5 m	kg									*7,520	7,210	*6,990	5,330	*4,380	*4,380	9.98 m
3.0 m	kg			*21,160	*21,160	*13,040	*13,040	*9,950	9,520	*8,350	6,820	*7,420	5,120	*4,530	4,120	10.23 m
1.5 m	kg					*15,760	13,190	*11,410	8,830	*9,190	6,430	*7,880	4,900	*4,820	3,990	10.25 m
G.L.	kg			*10,820	*10,820	*17,290	12,390	*12,470	8,320	*9,850	6,120	8,100	4,730	*5,280	4,020	10.05 m
-1.5 m	kg	*10,180	*10,180	*14,950	*14,950	*17,630	12,070	*12,920	8,040	*10,150	5,930	7,990	4,630	*6,040	4,230	9.62 m
-3.0 m	kg	*14,870	*14,870	*20,400	*20,400	*16,950	12,060	*12,670	7,970	*9,910	5,890			*7,340	4,720	8.91 m
-4.5 m	kg	*20,310	*20,310	*21,170	*21,170	*15,190	12,290	*11,490	8,100	*8,720	6,020			*8,060	5,700	7.85 m
-6.0 m	kg			*15,790	*15,790	*11,710	*11,710	*8,510	*8,510					*7,910	*7,910	6.26 m

SK350NLC		Boom: 6.5 m Arm: 2.6 m Bucket: without Shoe: 600 mm (Heavy Lift)										
B \ A		3.0 m		4.5 m		6.0 m		7.5 m		At Max. Reach		Radius
7.5 m	kg									*8,760	8,010	7.06 m
6.0 m	kg					*9,360	*9,360	*8,610	7,190	*8,540	6,420	8.00 m
4.5 m	kg			*13,460	*13,460	*10,470	9,700	*9,030	6,950	*8,510	5,600	8.58 m
3.0 m	kg					*11,770	9,070	*9,650	6,640	*8,600	5,180	8.87 m
1.5 m	kg					*12,800	8,570	*10,200	6,360	8,450	5,030	8.89 m
G.L.	kg			*17,830	12,340	*13,230	8,290	*10,460	6,190	8,690	5,140	8.66 m
-1.5 m	kg			*16,930	12,390	*12,940	8,230	*10,170	6,160	*9,090	5,570	8.15 m
-3.0 m	kg	*19,180	*19,180	*15,120	12,620	*11,730	8,370			*9,110	6,540	7.29 m
-4.5 m	kg	*14,570	*14,570	*11,740	*11,740					*8,590	*8,590	5.95 m

Notes:

- Do not attempt to lift or hold any load that is greater than these lift capacities at their specified lift point radius and heights. Weight of all accessories must be deducted from the above lift capacities.
- Lift capacities are based on machine standing on level, firm, and uniform ground. User must make allowance for job conditions such as soft or uneven ground, out of level conditions, side loads, sudden stopping of loads, hazardous conditions, experience of personnel, etc.
- Arm top defined as lift point.
- The above lifting capacities are in compliance with ISO 10567. They do not exceed 87% of hydraulic lifting capacity or 75% of tipping load. Lifting capacities marked with an asterisk (*) are limited by hydraulic capacity rather than tipping load.
- Operator should be fully acquainted with the Operator's and Maintenance Instructions before operating this machine. Rules for safe operation of equipment should be adhered to at all times.
- Lift capacities apply to only machine as originally manufactured and normally equipped by KOBELCO CONSTRUCTION MACHINERY CO., LTD.

2 Piece Boom Specifications



Working Ranges

Unit: m

Boom	3.16 m + 2.63 m			
Range	Arm	Short 2.6 m	Standard 3.3 m	Long 4.15 m
a- Max. digging reach		10.68	11.35	12.11
b- Max. digging reach at ground level		10.48	11.16	11.93
c- Max. digging depth		6.51	7.2	8.01
d- Max. digging height		12.09	12.65	13.17
e- Max. dumping clearance		8.72	9.28	9.80
f- Min. dumping clearance		0.82	0.12	0.73
g- Max. vertical wall digging depth		3.92	4.46	5.28
h- Min. swing radius		3.31	3.0	3.14
i- Horizontal digging stroke at ground level		6.67	8.03	9.63
j- Digging depth for 2.4 m (8') flat bottom		6.41	7.11	7.92
Bucket capacity ISO heaped m ³		1.60	1.40	1.20

Digging Force (ISO 6015)

Unit: kN

Arm length	Short 2.6 m	Standard 3.3 m	Long 4.15 m
Bucket digging force	222 244*	222 244*	222 244*
Arm crowding force	205 225*	163 180*	140 154*

*Power Boost engaged

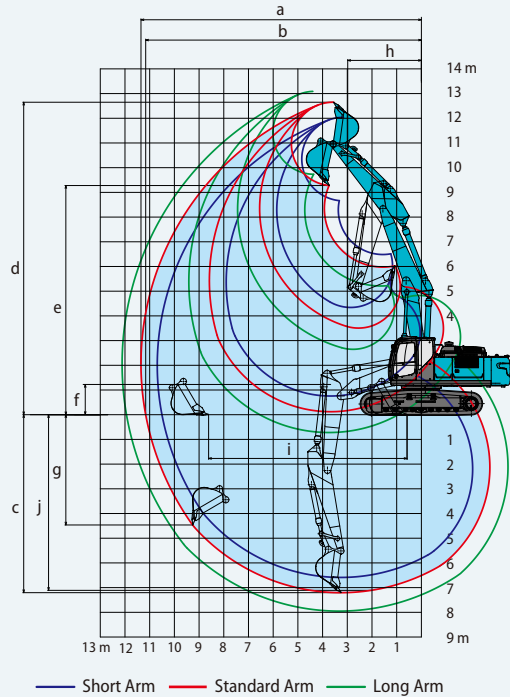

Operating Weight & Ground Pressure

In standard trim, with 2piece boom, 3.3 m arm, and 1.4 m³ ISO heaped bucket.

Shaped		Double grouser shoes		Triple grouser shoes (even height)		
Shoe width	mm	600	600	700	800	900
Overall width of crawler	SK350LC	3,190	3,190	3,290	3,390	3,490
	SK350NLC	2,990	2,990	3,090	-	-
Ground pressure	SK350LC	71	70	62	55	49
	SK350NLC	71	70	62	-	-
Operating weight	SK350LC	38,100	37,600	38,500	38,900	39,300
	SK350NLC	38,000	37,600	38,400	-	-



Dimensions

Unit: mm

Arm length	Short 2.6 m	Standard 3.3 m	Long 4.15 m
A Overall length	11,290	11,270	11,270
B Overall height (to top of boom)	3,410	3,360	3,670
C Overall width of crawler	SK350LC	3,190	
	SK350NLC	2,990	
D Overall height (to top of cab)	3,200		
E Ground clearance of rear end*	1,190		
F Ground clearance*	500		
G Tail swing radius	3,600		
G' Distance from center of swing to rear end	3,600		
H Tumbler distance	4,050		
I Overall length of crawler	4,960		
J Track gauge	SK350LC	2,590	
	SK350NLC	2,390	
K Shoe width	600		
L Overall width of upperstructure	2,980		

*Without including height of shoe

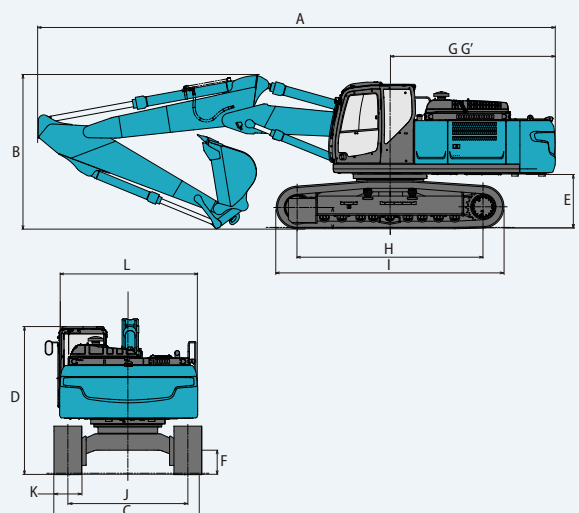

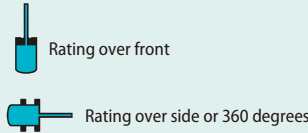
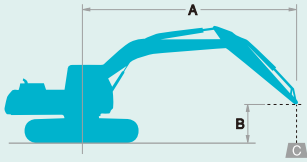

A: Reach from swing centerline to arm top
 B: Arm top height above/below ground
 C: Lifting capacities in Kilograms
 Bucket: Without bucket
 Relief valve setting: 37.8 MPa (385 kgf/cm²)

SK350LC		Boom: 2 piece boom Arm: 3.3 m Bucket: without Shoe: 600 mm (Heavy Lift)												
A \ B		3.0 m		4.5 m		6.0 m		7.5 m		9.0 m		At Max. Reach		Radius
10.5 m	kg			*9,280	*9,280							*8,430	*8,430	4.63 m
9.0 m	kg					*7,950	*7,950					*6,880	*6,880	6.70 m
7.5 m	kg					*11,010	*11,010	*6,790	*6,790			*6,000	*6,000	7.92 m
6.0 m	kg			*11,880	*11,880	*11,440	11,290	*5,780	*5,780			*5,700	*5,700	8.82 m
4.5 m	kg			*15,800	*15,800	*12,220	10,710	*5,090	*5,090	*6,010	5,650	*5,610	5,270	9.35 m
3.0 m	kg	*25,710	*25,710	*17,600	15,170	*13,010	10,020	*4,970	*4,970	*6,110	5,500	*5,690	4,940	9.61 m
1.5 m	kg	*27,810	27,660	*18,080	14,060	*13,350	9,440	*5,520	*5,520	*6,410	5,340	*5,950	4,830	9.64 m
G.L.	kg	*22,850	*22,850	*16,900	13,610	*12,910	9,070	*6,850	6,710	*6,790	5,240	*6,410	4,940	9.43 m
-1.5 m	kg	*13,570	*13,570	*14,510	13,560	*11,540	8,950	*8,730	6,620			*6,210	5,300	8.96 m
-3.0 m	kg			*11,000	*11,000	*9,050	9,030	*6,670	*6,670			*4,980	*4,980	8.19 m

SK350LC		Boom: 2 piece boom Arm: 4.15 m Bucket: without Shoe: 600 mm (Heavy Lift)												
A \ B		3.0 m		4.5 m		6.0 m		7.5 m		9.0 m		At Max. Reach		Radius
10.5 m	kg					*6,110	*6,110					*5,800	*5,800	6.06 m
9.0 m	kg					*8,460	*8,460	*6,160	*6,160			*4,930	*4,930	7.75 m
7.5 m	kg					*8,600	*8,600	*5,270	*5,270			*4,540	*4,540	8.88 m
6.0 m	kg					*9,190	*9,190	*9,070	7,990	*5,200	*5,200	*4,360	*4,360	9.64 m
4.5 m	kg			*11,810	*11,810	*11,270	10,960	*9,470	7,670	*4,880	*4,880	*4,320	*4,320	10.13 m
3.0 m	kg	*24,380	*24,380	*16,330	15,760	*12,240	10,190	*9,920	7,260	*4,820	*4,820	*4,400	4,270	10.37 m
1.5 m	kg	*27,360	*27,360	*17,650	14,310	*12,920	9,470	*3,830	*3,830	*5,140	*5,140	*4,600	4,170	10.39 m
G.L.	kg	*9,090	*9,090	*17,460	13,490	*12,930	8,960	*4,950	*4,950	*5,820	5,060	*4,950	4,230	10.20 m
-1.5 m	kg	*13,370	*13,370	*15,870	13,200	*12,100	8,700	*6,820	6,390	*6,560	4,980	*5,530	4,480	9.77 m
-3.0 m	kg	*16,040	*16,040	*13,080	*13,080	*10,290	8,660	*7,910	6,370	*5,260	5,050	*5,080	5,010	9.07 m
-4.5 m	kg			*8,930	*8,930	*7,180	*7,180	*4,900	*4,900			*3,650	*3,650	8.03 m

SK350LC		Boom: 2 piece boom Arm: 2.6 m Bucket: without Shoe: 600 mm (Heavy Lift)											
A \ B		3.0 m		4.5 m		6.0 m		7.5 m		At Max. Reach		Radius	
9.0 m	kg			*14,100	*14,100					*11,940	*11,940	5.68 m	
7.5 m	kg			*14,020	*14,020	*7,550	*7,550			*10,480	8,290	7.15 m	
6.0 m	kg	*17,220	*17,220	*15,020	*15,020	*12,050	10,970	*7,180	*7,180	*9,750	6,690	8.08 m	
4.5 m	kg	*18,730	*18,730	*16,730	15,980	*12,700	10,380	*6,530	*6,530	*9,100	5,870	8.65 m	
3.0 m	kg	*24,140	*24,140	*17,580	14,830	*13,260	9,730	*6,440	*6,440	*8,520	5,460	8.94 m	
1.5 m	kg	*27,960	*27,960	*17,980	13,920	*13,240	9,220	*7,100	6,820	*8,050	5,330	8.97 m	
G.L.	kg	*25,280	*25,280	*15,550	13,550	*7,760	*7,760	*8,460	6,660	*7,370	5,480	8.74 m	
-1.5 m	kg	*13,790	*13,790	*12,520	*12,520	*10,510	8,940	*8,040	6,660	*6,360	5,980	8.23 m	
-3.0 m	kg			*8,540	*8,540	*7,370	*7,370			*4,620	*4,620	7.38 m	

Notes:

- Do not attempt to lift or hold any load that is greater than these lift capacities at their specified lift point radius and heights. Weight of all accessories must be deducted from the above lift capacities.
- Lift capacities are based on machine standing on level, firm, and uniform ground. User must make allowance for job conditions such as soft or uneven ground, out of level conditions, side loads, sudden stopping of loads, hazardous conditions, experience of personnel, etc.
- Arm top defined as lift point.
- The above lifting capacities are in compliance with ISO 10567. They do not exceed 87% of hydraulic lifting capacity or 75% of tipping load. Lifting capacities marked with an asterisk (*) are limited by hydraulic capacity rather than tipping load.
- Operator should be fully acquainted with the Operator's and Maintenance Instructions before operating this machine. Rules for safe operation of equipment should be adhered to at all times.
- Lift capacities apply to only machine as originally manufactured and normally equipped by KOBELCO CONSTRUCTION MACHINERY CO., LTD.

Lift Capacities

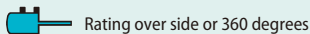
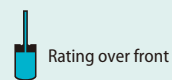
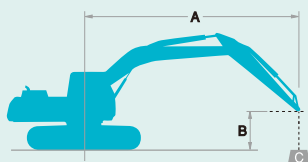

A: Reach from swing centerline to arm top
 B: Arm top height above/below ground
 C: Lifting capacities in Kilograms
 Bucket: Without bucket
 Relief valve setting: 37.8 MPa (385 kgf/cm²)

SK350NLC		Boom: 2 piece boom		Arm: 3.3 m		Bucket: without		Shoe: 600 mm (Heavy Lift)		At Max. Reach		Radius		
B	A	3.0 m		4.5 m		6.0 m		7.5 m		9.0 m				
10.5 m	kg			*9,280	*9,280							*8,430	*8,430	4.63 m
9.0 m	kg					*7,950	*7,950					*6,880	*6,880	6.70 m
7.5 m	kg					*11,010	10,790	*6,790	*6,790			*6,000	*6,000	7.92 m
6.0 m	kg			*11,880	*11,880	*11,440	10,460	*5,780	*5,780			*5,700	5,460	8.82 m
4.5 m	kg			*15,800	15,330	*12,220	9,890	*5,090	*5,090	*6,010	5,210	*5,610	4,860	9.35 m
3.0 m	kg	*25,710	*25,710	*17,600	13,830	*13,010	9,220	*4,970	*4,970	*6,110	5,060	*5,690	4,540	9.61 m
1.5 m	kg	*27,810	24,420	*18,080	12,760	*13,350	8,640	*5,520	*5,520	*6,410	4,910	*5,950	4,440	9.64 m
G.L.	kg	*22,850	*22,850	*16,900	12,320	*12,910	8,290	*6,850	6,150	*6,790	4,810	*6,410	4,530	9.43 m
-1.5 m	kg	*13,570	*13,570	*14,510	12,270	*11,540	8,160	*8,730	6,070			*6,210	4,870	8.96 m
-3.0 m	kg			*11,000	*11,000	*9,050	8,250	*6,670	6,160			*4,980	*4,980	8.19 m

SK350NLC		Boom: 2 piece boom		Arm: 4.15 m		Bucket: without		Shoe: 600 mm (Heavy Lift)		At Max. Reach		Radius		
B	A	3.0 m		4.5 m		6.0 m		7.5 m		9.0 m				
10.5 m	kg					*6,110	*6,110					*5,800	*5,800	6.06 m
9.0 m	kg					*8,460	*8,460	*6,160	*6,160			*4,930	*4,930	7.75 m
7.5 m	kg					*8,600	*8,600	*5,270	*5,270			*4,540	*4,540	8.88 m
6.0 m	kg					*9,190	*9,190	*9,070	7,400	*5,200	*5,200	*4,360	*4,360	9.64 m
4.5 m	kg			*11,810	*11,810	*11,270	10,130	*9,470	7,090	*4,880	*4,880	*4,320	4,180	10.13 m
3.0 m	kg	*24,380	*24,380	*16,330	14,390	*12,240	9,380	*9,920	6,690	*4,820	*4,820	*4,400	3,920	10.37 m
1.5 m	kg	*27,360	*27,360	*17,650	12,990	*12,920	8,670	*3,830	*3,830	*5,140	4,790	*4,600	3,810	10.39 m
G.L.	kg	*9,090	*9,090	*17,460	12,190	*12,930	8,170	*4,950	*4,950	*5,820	4,630	*4,950	3,870	10.20 m
-1.5 m	kg	*13,370	*13,370	*15,870	11,910	*12,100	7,910	*6,820	5,830	*6,560	4,550	*5,530	4,100	9.77 m
-3.0 m	kg	*16,040	*16,040	*13,080	11,950	*10,290	7,880	*7,910	5,810	*5,260	4,620	*5,080	4,590	9.07 m
-4.5 m	kg			*8,930	*8,930	*7,180	*7,180	*4,900	*4,900			*3,650	*3,650	8.03 m

SK350NLC		Boom: 2 piece boom		Arm: 2.6 m		Bucket: without		Shoe: 600 mm (Heavy Lift)		At Max. Reach		Radius
B	A	3.0 m		4.5 m		6.0 m		7.5 m		9.0 m		
9.0 m	kg			*14,100	*14,100					*11,940	11,220	5.68 m
7.5 m	kg			*14,020	*14,020	*7,550	*7,550			*10,480	7,670	7.15 m
6.0 m	kg	*17,220	*17,220	*15,020	*15,020	*12,050	10,140	*7,180	7,070	*9,750	6,180	8.08 m
4.5 m	kg	*18,730	*18,730	*16,730	14,610	*12,700	9,570	*6,530	*6,530	*9,100	5,410	8.65 m
3.0 m	kg	*24,140	*24,140	*17,580	13,500	*13,260	8,930	*6,440	*6,440	*8,520	5,020	8.94 m
1.5 m	kg	*27,960	25,050	*17,980	12,620	*13,240	8,430	*7,100	6,260	*8,050	4,900	8.97 m
G.L.	kg	*25,280	24,320	*15,550	12,260	*7,760	*7,760	*8,460	6,100	*7,370	5,040	8.74 m
-1.5 m	kg	*13,790	*13,790	*12,520	12,310	*10,510	8,160	*8,040	6,110	*6,360	5,490	8.23 m
-3.0 m	kg			*8,540	*8,540	*7,370	*7,370			*4,620	*4,620	7.38 m

Notes:

- Do not attempt to lift or hold any load that is greater than these lift capacities at their specified lift point radius and heights. Weight of all accessories must be deducted from the above lift capacities.
- Lift capacities are based on machine standing on level, firm, and uniform ground. User must make allowance for job conditions such as soft or uneven ground, out of level conditions, side loads, sudden stopping of loads, hazardous conditions, experience of personnel, etc.
- Arm top defined as lift point.
- The above lifting capacities are in compliance with ISO 10567. They do not exceed 87% of hydraulic lifting capacity or 75% of tipping load. Lifting capacities marked with an asterisk (*) are limited by hydraulic capacity rather than tipping load.
- Operator should be fully acquainted with the Operator's and Maintenance Instructions before operating this machine. Rules for safe operation of equipment should be adhered to at all times.
- Lift capacities apply to only machine as originally manufactured and normally equipped by KOBELCO CONSTRUCTION MACHINERY CO., LTD.

STANDARD EQUIPMENT

ENGINE

- HINO J08EYD-KSDA diesel engine with turbocharger and intercooler, EU Stage V compliant
- Automatic engine deceleration
- Auto Idle Stop (AIS)
- Batteries (2 x 12V - 120Ah)
- Starting motor (24V - 5 kW), 60 amp alternator
- Automatic engine shut-down for low engine oil pressure
- Engine oil pan drain cock
- Double element air cleaner
- Refueling pump

CONTROL

- Working mode selector (H-mode, S-mode and ECO-mode)
- Power Boost
- Heavy lift
- Object Handling Kit (boom and arm safety valve + hook + overload alarm)
- Extra N&B piping (proportional hand controlled)

SWING SYSTEM & TRAVEL SYSTEM

- Swing rebound prevention system
- Straight propel system
- Two-speed travel with automatic shift down
- Sealed & lubricated track links
- Grease-type track adjusters
- Automatic swing brake

HYDRAULIC

- Arm regeneration system
- Auto warm up system
- Aluminum hydraulic oil cooler
- Hydraulic fluid filter clog detector
- Hydraulic pressure adjustment function for N&B piping
- Quick hitch piping

MIRRORS, LIGHTS & CAMERAS

- Rearview mirror
- Three front working lights
- Rear & right side cameras

CAB & CONTROL

- Two control levers, pilot-operated
- Horn, electric
- Cab light (interior)
- Luggage tray
- Large cup holder
- Detachable two-piece floor mat
- Headrest
- Handrails
- Intermittent windshield wiper with double-spray washer
- Skylight
- Tinted safety glass
- Pull-up type front window and removable lower front window
- Easy-to-read multi-display color monitor
- Automatic air conditioner
- Emergency escape hammer
- Air suspension seat with heater (Optional for N&B piping specification)
- Radio, AM/FM stereo with speaker
- USB pin
- Top guard (Level II)
- Remote machine monitoring system "KOMEXS"
- Tow eyes

OPTIONAL EQUIPMENT

- Various optional arms
- Wide range of shoes
- Additional track guide
- Two cab lights
- Extended guard rail

- Rain visor (may interfere with bucket action)
- Cab guard
- Travel alarm
- Lower under cover
- Bigger capacity P4 pump and steel PTO housing

Note: This catalogue may contain attachments and optional equipment that are not available in your area. And it may contain photographs of machines with specifications that differ from those of machines sold in your areas. Please consult your nearest KOBELCO distributor for those items you require.
Due to our policy of continuous product improvements all designs and specifications are subject to change without advance notice.
Copyright by **KOBELCO CONSTRUCTION MACHINERY CO., LTD.** No part of this catalogue may be reproduced in any manner without notice.

KOBELCO CONSTRUCTION MACHINERY EUROPE B.V.

Veluwezoom 15
1327 AE Almere
The Netherlands
www.kobelco-europe.com

Enquiries To: